



STUDY GUIDE:

PHYSICS SL



IB Academy Physics Study Guide

Available on learn.ib.academy

Author: Eva Rouwmaat, Max Kraan
Contributing Authors: Daniel Rutte, Victor Onink, Nikita Smolnikov

Design

Rational

Typesetting



Special thanks: Vilijam Strovanovski and Tijana Randjelovic

*This work may be shared digitally and in printed form,
but it may not be changed and then redistributed in any form.*

Copyright © 2019, IB Academy
Version: PhySL.4.1.190829



This work is published under the Creative Commons
BY-NC-ND 4.0 International License. To view a copy of this
license, visit creativecommons.org/licenses/by-nc-nd/4.0

This work may not be used for commercial purposes other than by IB Academy, or parties directly licenced by IB Academy. If you acquired this guide by paying for it, or if you have received this guide as part of a paid service or product, directly or indirectly, we kindly ask that you contact us immediately.

Laan van Puntenburg 2a
3511ER, Utrecht
The Netherlands

ib.academy
info@ib.academy
+31 (0) 30 4300 430

INTRODUCTION

Welcome to the IB.Academy Study Guide for Physics.

We are proud to present our study guides and hope that you will find them helpful. They are the result of a collaborative undertaking between our tutors, students and teachers from schools across the globe. Our mission is to create the most simple yet comprehensive guides accessible to IB students and teachers worldwide. We are firm believers in the open education movement, which advocates for transparency and accessibility of academic material. As a result, we embarked on this journey to create these study guides that will be continuously reviewed and improved. Should you have any comments, feel free to contact us.

For more information and details on our revision courses, be sure to visit our website at ib.academy. We hope that you will enjoy our guides and best of luck with your studies.

IB.Academy Team

TABLE OF CONTENTS

1.	Measurements and mathematical foundations	7
2.	Mechanics	17
3.	Thermal physics	31
4.	Oscillations and waves	41
5.	Electricity and magnetism	55
6.	Circular motion and gravitation	67
7.	Atomic and nuclear physics	73
8.	Energy production	87
	Exam tips	97

TABLE OF CONTENTS

MEASUREMENTS AND MATHEMATICAL FOUNDATIONS

■	1.1. Notation	8
■	1.2. Measurements	11
■	1.3. Vectors	14

1.1 Notation

When writing down the final value of a measurement or calculation, three things are important to remember: use the right unit (1.1.1), use scientific notation or metric multipliers when the number is very large or very small (1.1.2), and use the right amount of significant figures (1.1.3).

1.1.1 Fundamental and derived SI units

Fundamental units

There are seven fundamental SI units from which many other units can be derived. You only need to know six of them.

Time	seconds	s
Displacement	meters	m
Mass	kilograms	kg
Temperature	kelvin	K
Amount of substance	mole	mol
Current	ampere	A

Derived units

All other units can be expressed as a combination of these fundamental units.

Example.

We know that $\text{speed} = \frac{\text{displacement}}{\text{time}}$ or $v = \frac{s}{t}$.

The unit for v therefore is $\frac{\text{unit of displacement}}{\text{unit of time}} = \frac{[\text{m}]}{[\text{s}]} = \text{m s}^{-1}$.

In a similar manner, we can derive other units:

Quantity	Calculation	Units	Derived unit	Name	Symbol
Force	$F = m \times a$	$[\text{kg}] \times [\text{m s}^{-2}]$	kg m s^{-2}	newton	N
Charge	$q = I \times t$	$[\text{A}] \times [\text{s}]$	A s	coulomb	C
Electric field	$E = \frac{F_E}{q}$	$\frac{[\text{kg m s}^{-2}]}{[\text{A s}]}$	$\text{kg m s}^{-3} \text{ A}^{-1}$	-	-

1.1.2 Order of magnitude

Order of magnitude measure the size of a number, with each order of magnitude being equivalent to a multiple of 10.

The order of magnitude can be indicated in two ways:

- Using scientific notation: writing numbers in the form $N \times 10^m$, where m is the order of magnitude and $1 \leq N < 10$.
- Using metric multipliers: prefixes that precede units to indicate its order of magnitude. These are shown in Table 1.1.

Table 1.1: Metric (SI) multipliers

Prefix	Symbol	Power	Prefix	Symbol	Power
deci	d	10^{-1}	deca	da	10^1
centi	c	10^{-2}	hecto	h	10^2
milli	m	10^{-3}	kilo	k	10^3
micro	μ	10^{-6}	mega	M	10^6
nano	n	10^{-9}	giga	G	10^9
pico	p	10^{-12}	tera	T	10^{12}
femto	f	10^{-15}	peta	P	10^{15}
atto	a	10^{-18}	exa	E	10^{18}
zepto	z	10^{-21}	zetta	Z	10^{21}
yocto	y	10^{-24}	yotta	Y	10^{24}

DB page 6

Example.

1500 m has an order of magnitude 3. In scientific notation this is written as 1.5×10^3 m. Using metric multipliers this is 1.5 km.

Because 15 m is 100 times smaller than 1500 m, it is two orders of magnitude smaller.

1.1.3 Significant figures

Significant figures of a number show the accuracy of a measurement. To determine the amount of significant figures of a number, use the following rules:

1. Non-zero digits are always significant.
2. Zero digits between non-zero digits are significant.
3. Zero digits after non-zero digits are significant only if they are placed after the decimal point.
4. But zero digits before non-zero digits are not significant, even if they are placed after the decimal point.

Example.

- 809.0 has 4 significant figures $\overset{1}{8}\overset{2}{0}\overset{3}{9}\overset{4}{.0}$ rules 1, 2 and 3
- 0.002 has 1 significant figure $0.\overset{1}{0}02$ rules 1 and 4
- 04.400 has 4 significant figures $0\overset{1}{4}.\overset{2}{4}\overset{3}{0}\overset{4}{0}$ rules 1, 3 and 4

How many significant figures does your answer need?

Adding or subtracting

Take the least number of decimal places used in your calculation:

$7.34 + 4.8 = 12.14$, but 4.8 has only 1 decimal place so the answer should be expressed as 12.1.

Multiplying or dividing

Take the least number of significant figures used in your calculation:

$1.34 \times 4.8 = 6.432$, but 4.8 has 2 significant figures so the answer should be expressed as 6.4.

Read from a graph

Take the number of significant figures corresponding to the smallest grid on the graph: eg., for grid units of 0.1, a read value of 3.65 should be expressed as 3.7.

A good rule of thumb is that you need the same amount of significant figures in your answer as the least amount of significant figures used in the question.

1.2 Measurements

1.2.1 Calculating uncertainties

Due to the limited precision in measuring devices, all measurements contain an uncertainty. On the exam, you are therefore often asked to determine this uncertainty.



Absolute uncertainty the uncertainty in a measurement as an absolute value, eg., ± 0.5 .

Fractional uncertainty the uncertainty in a measurement as a fraction of the measurement: $\frac{\text{absolute uncertainty}}{\text{measurement}}$

Percentage uncertainty the fractional uncertainty expressed as a percentage: $\frac{\text{absolute uncertainty}}{\text{measurement}} \times 100\%$

How can you calculate the uncertainty?

Adding or subtracting

Sum of absolute uncertainties: $\Delta y = \Delta a + \Delta b$

Multiplying or dividing

Sum of fractional uncertainties: $\frac{\Delta y}{y} = \frac{\Delta a}{a} + \frac{\Delta b}{b}$

Exponent $y = a^n$

Multiply fractional uncertainty by n : $\frac{\Delta y}{y} = \left| n \frac{\Delta a}{a} \right|$

Example.

In an experiment, a student measures the average period T of a swinging pendulum as $T = 2.50 \pm 0.02$ s. The length of the pendulum is $L = 1.60 \pm 0.01$ m. Determine the percentage uncertainty of the acceleration g using $g = \frac{4\pi^2 L}{T^2}$.

Uncertainty for exponent: $\frac{\Delta T^2}{T^2} = \left| 2 \frac{\Delta T}{T} \right| = 2 \frac{0.02}{2.50} = 0.016$

Uncertainty for dividing: $\frac{\Delta g}{g} = \frac{\Delta L}{L} + \frac{\Delta T^2}{T^2} = \frac{0.01}{1.60} + 0.016 = 0.02225$

Percentage uncertainty: $\frac{\Delta g}{g} \times 100\% = 2.225\%$, so about 2%.

1.2.2 Working with graphs

Graphs are used to show the relation between two variables. As you can see below, they can contain a lot of information. There are therefore various types of questions on graphs you can expect on your exam.

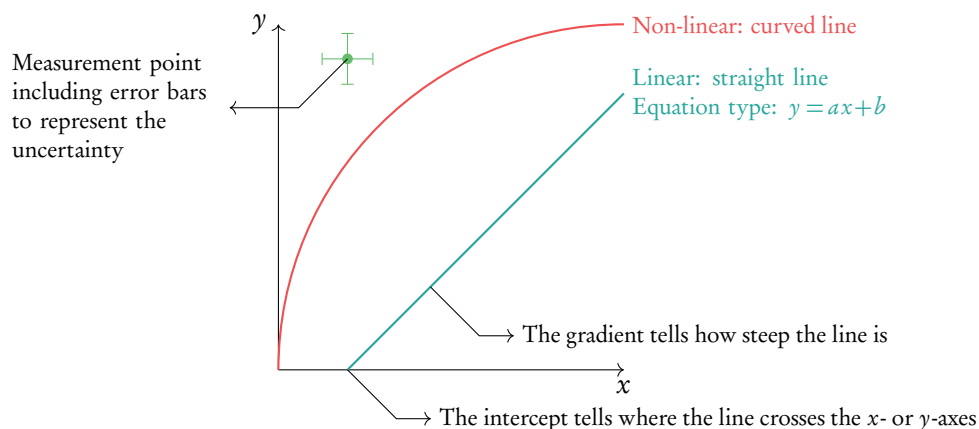

Determine the uncertainty (for a specific point):

1. Measure the length of the corresponding error bar.
2. Divide by 2 for the absolute error, e.g., an error bar of length 0.2 gives an absolute uncertainty of ± 0.1 . Pay close attention to the type of uncertainty you are asked to calculate.

Draw the line of best fit:

1. Identify the type of progression the points follow: linear or non-linear.
2. Draw a smooth line or curve through all the error bars.

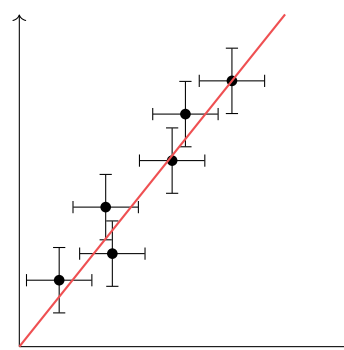

Find the gradient:

1. Find two points on the line as far apart as possible.
2. Measure the x - and y -value at each point.
3. Calculate the gradient a using

$$a = \frac{y_2 - y_1}{x_2 - x_1}$$

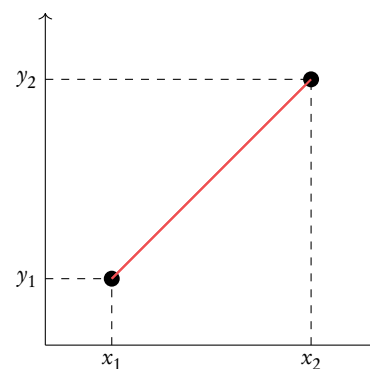

1.2.3 Random and systematic errors

Every scientist needs to deal with errors in their experiments. In this case, an error is not the same as a mistake: we're assuming you're a perfectly good scientist who does not make calculation or reading mistakes. We distinguish between two types of errors:

Random errors

Affect each measurement in a random manner.

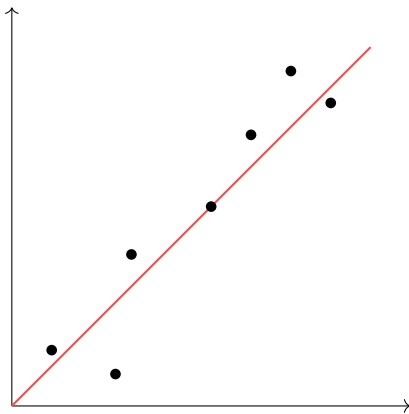

Caused by fluctuations in instrument readings or effects due to changes in the surroundings.

Reduced by repeated readings.

Systematic error or zero error

Affects each measurement in the same manner.

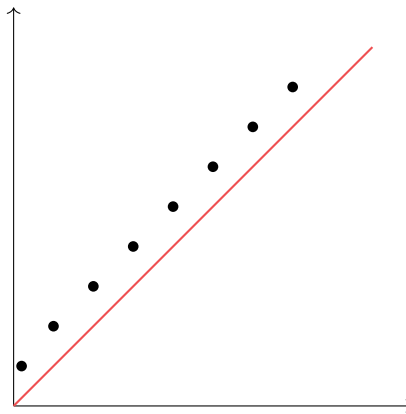

Reduced by ensuring instruments are properly calibrated, or mathematically removing known offsets. The size of the error can be determined by checking the intercept.

Because the gradient stays the same, not all calculations are affected by this error.

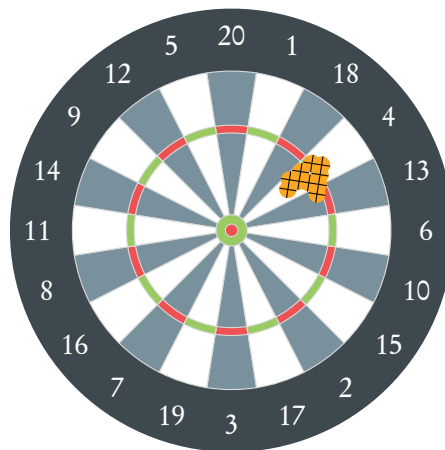
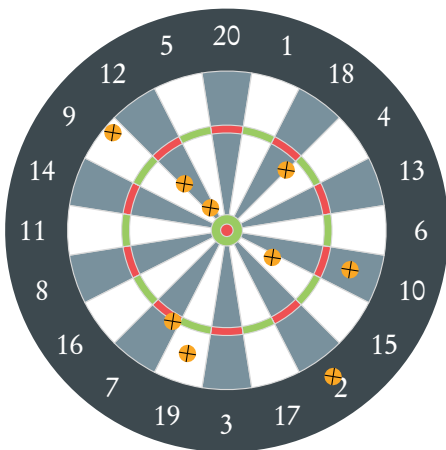

1.3 Vectors

1.3.1 Vectors and scalars



A **vector** is a quantity with a magnitude and a direction.

A **scalar** is a quantity which has only a magnitude.

Example.

Speed only has a *magnitude*, so it is a *scalar*. Velocity however has a *magnitude* and a *direction*, which makes it a *vector*.

Energy has no *direction*, so it is a *scalar*. Force has a *magnitude* and a *direction* and therefore is a *vector*.

1.3.2 Vector calculations

Just like scalars, you can add and subtract vectors, but the procedure is somewhat different since you need to take the vector's direction into account.

Addition

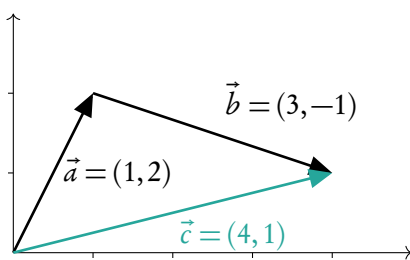

To add to vectors, connect the tail of the one to the point of the other.

$$\vec{a} + \vec{b} = \begin{pmatrix} 1 \\ 2 \end{pmatrix} + \begin{pmatrix} 3 \\ -1 \end{pmatrix} = \begin{pmatrix} 4 \\ 1 \end{pmatrix}$$

Subtraction

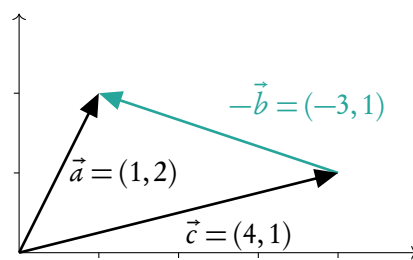

To subtract vectors, connect the two points.

$$\vec{a} - \vec{c} = \begin{pmatrix} 1 \\ 2 \end{pmatrix} - \begin{pmatrix} 4 \\ 1 \end{pmatrix} = \begin{pmatrix} -3 \\ 1 \end{pmatrix} = -\vec{b}$$

As you can see for \vec{b} , going along the opposite direction of a vector reverses the signs of its values.

Multiplication and division by scalars

Multiplying and dividing a vector \vec{a} by a scalar c is straightforward: the result is $c \cdot \vec{a}$ and $\frac{1}{c}\vec{a}$, respectively.

Multiplication for $c = 2$ looks like this:

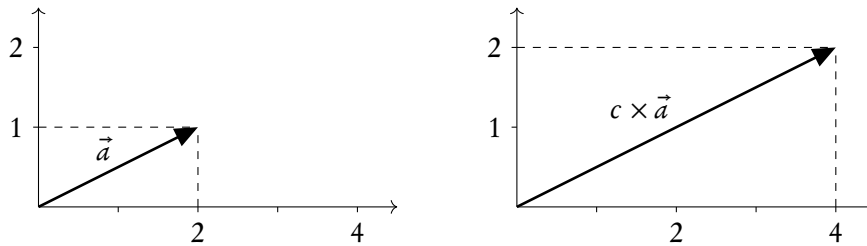

Resolution of vectors

Especially in mechanics, there will be cases where you'll need to split a vector into a vertical and a horizontal part. This is done as follows:

$$A_h = A \cos \vartheta$$

$$A_v = A \sin \vartheta$$

The total length of a vector is equal to

$$|A| = \sqrt{|A_h|^2 + |A_v|^2}$$

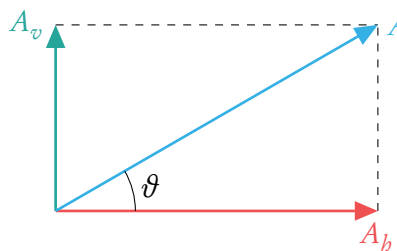

MECHANICS

2

■	2.1. Motion	18
■	2.2. Forces	23
■	2.3. Work, energy and power	25
■	2.4. Momentum and impulse	28

2.1 Motion

2.1.1 Equations of motion



Displacement is a vector quantity stating an object's change in position (whereas distance is a scalar quantity).

Velocity is a vector quantity stating the rate of change of displacement (whereas speed is a scalar quantity).

Acceleration is a vector quantity stating the rate of change of velocity.

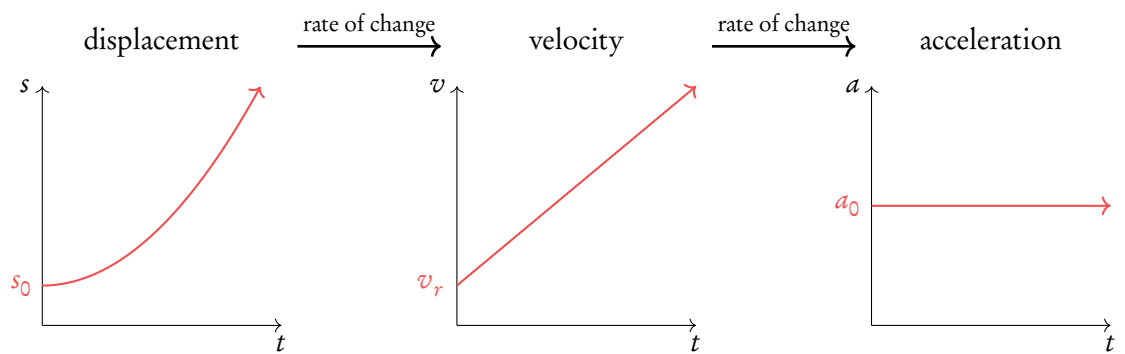

As you can see in the right graph, the acceleration does not change. This type of motion is called *uniformly accelerated motion*: motion of a body under constant (possibly zero) acceleration. All calculations involving acceleration will be on uniformly accelerated motion.

DB 2.1

The other two graphs show velocity is linear and displacement is quadratic. This is reflected by the equations of motion:

$$v = u + at$$

$$s = ut + \frac{1}{2}at^2$$

where u is the initial velocity.

For linking displacement to velocity, we have

$$s = \frac{(u + v)t}{2}$$

$$v^2 = u^2 + 2as$$

- when $a = 0$: the *instantaneous* displacement
- when $a \neq 0$: the *average* displacement

Example.

You bungee jump off a cliff. What distance do you cover during the fourth second? Air resistance is negligible.

Since we need to deal with time t , acceleration a , and distance s , we can use

$$s = ut + \frac{1}{2}at^2$$

The fourth second starts at $t = 3$ s and ends at $t = 4$ s. Since you let yourself fall, the initial velocity $u = 0$ m/s. The acceleration is equal to gravitational acceleration, $g = 9.81$ m/s².

$$s_1 = 0 + \frac{1}{2} \cdot 9.81 \cdot 3^2 \approx 44$$

$$s_2 = 0 + \frac{1}{2} \cdot 9.81 \cdot 4^2 \approx 78$$

$$s_2 - s_1 = 34 \text{ m}$$

so the distance covered during the fourth second is 34 meters.



Relative velocity between two bodies is the velocity of one body in the rest frame of the other. The total velocity v is equal to the velocity of the observer, v_o , plus the velocity of the object relative to the observer, v_r :

$$v = v_o + v_r$$

Example.

A train is driving with 25.5 m/s. A train passenger rolls a ball towards the rear of the train with 3.4 m/s. What is the velocity of the ball?

$$v = v_o + v_r = 25.5 - 3.4 = 22.1 \text{ m/s}$$

2.1.2 Graphs describing motion

When given a graph with time on the x -axis and a , v or s on the y -axis, you need to know how to calculate other quantities using that graph.

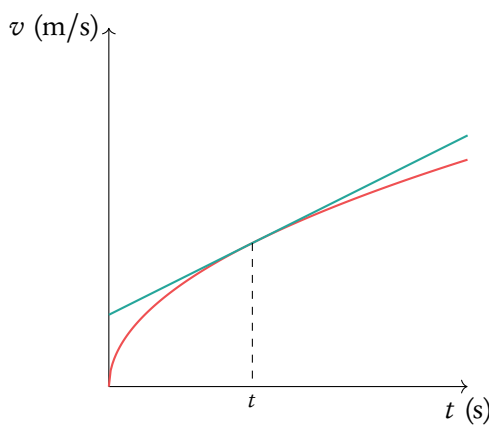
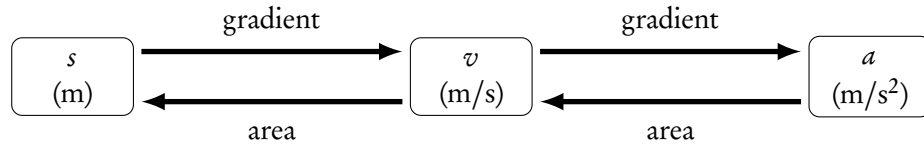

What is the acceleration?

To get from a graph with velocity v to acceleration a , calculate the gradient for the right time point t .

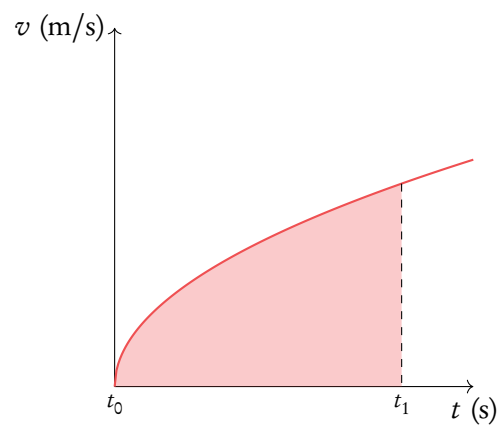

What is the distance covered?

To get from a graph with velocity v to distance s , calculate the area under the line up until the right time point t .

2.1.3 Projectile motion

A special type of motion is projectile motion, which deals with objects as they fly through the air (a ball, for example). The trick with projectile motion is that you can break this motion up in a x - and y -component and solve them independently. (When doing so, you can always neglect air resistance.)

Velocity

When given the initial velocity with magnitude v_0 and direction ϑ , based on resolving vectors in Section 1.3.2:

$$v_x = v_0 \cos \vartheta$$

$$v_y = v_0 \sin \vartheta$$

Displacement

x-component

There are no forces on the projectile in the x -direction, so $a = 0$. To calculate the displacement, we can therefore use:

$$s_x = s_{x,0} + v_x t$$

where $s_{x,0}$ is the initial displacement and v_x is the velocity of the x -component.

y-component

Now we have to take into account gravitational acceleration g :

$$s_y = s_{y,0} + v_y t + \frac{1}{2} g t^2$$

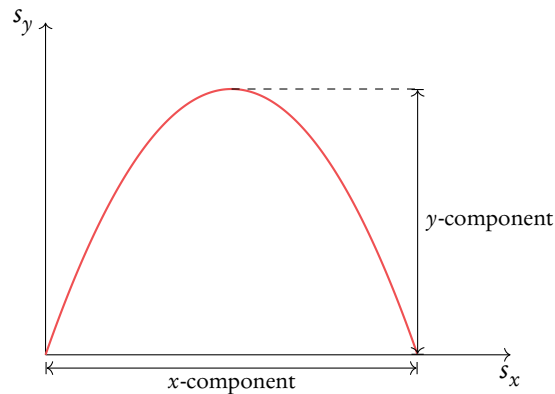

Since the y -component determines the object's position above the ground, it should be used to determine at what time t , it does that. So to find out anything about time you'll have to use this formula.

Example

A centaur shoots an arrow at a 30° angle with an initial velocity of $v_0 = 50$ m/s and initial displacement of 0.

1. How long does it take for the arrow to hit the ground?

This question is about time t , so we'll have to look at the displacement of the y -component:

$$s_y = s_{y,0} + v_y t + \frac{1}{2} g t^2$$

At $t = t_{\max}$ the arrow returns to its original position, $s_y = 0$, so:

$$s_{y,0} = s_{y,0} + v_{y,0} t_{\max} + \frac{1}{2} g t_{\max}^2$$

$$0 = v_{y,0} t_{\max} + \frac{1}{2} g t_{\max}^2$$

$$-v_{y,0} t_{\max} = \frac{1}{2} g t_{\max}^2$$

$$v_{y,0} = v_0 \sin \vartheta = 50 \cdot \sin 30^\circ = 50 \cdot \frac{1}{2} = 25$$

$$25 = \frac{1}{2} \cdot 9.81 \cdot t_{\max}$$

$$t_{\max} \approx 5.1 \text{ s}$$

Example.

2. How far does the arrow fly?

$$s_x = s_{x,0} + v_{x,0} t_{\max}$$

$$v_{x,0} = v_0 \cos \vartheta = 50 \cdot \cos 30^\circ = 50 \cdot \frac{\sqrt{3}}{2} = 25\sqrt{3}$$

$$s_x = 0 + 25\sqrt{3} \cdot 5.1 \approx 2.2 \times 10^2 \text{ m}$$

2.1.4 Fluid motion

When a parachutist jumps out of a plane, his speed will increase due to gravitational acceleration. Does this mean the parachutist will just go faster and faster? It turns out there is a limit to the speed he can reach. This maximum is called terminal velocity.



Terminal velocity the maximum speed that a freely falling object eventually reaches because of the resistance of the surrounding medium.

As the parachutist starts falling faster, the air resistance will increase because it depends on velocity. Eventually the air resistance becomes so large that the parachutist stops accelerating.

The next graph shows the change in velocity over time:

t_1
ball accelerates due to gravity

t_2
ball reaches terminal velocity when air resistance equals weight

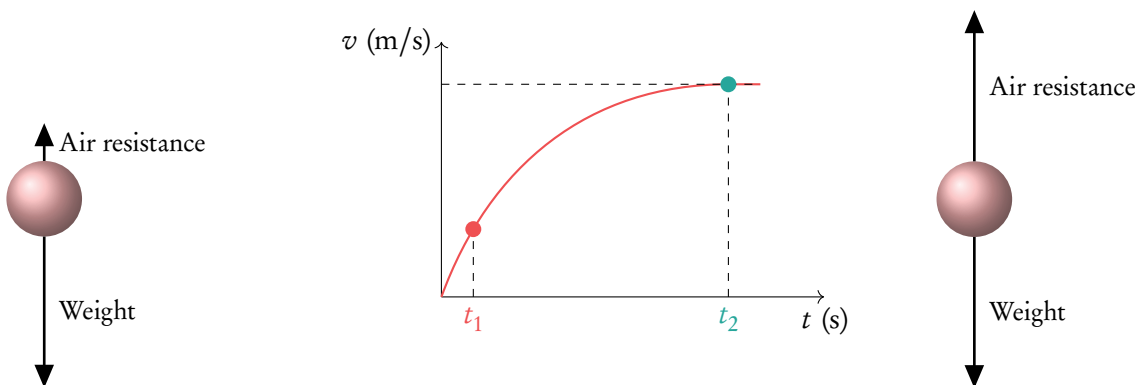

2.2 Forces

A physics exam would not be complete without a question about forces acting on an object.

To simplify such questions, we can approach objects as point particles, especially when drawing free body diagrams.



A force is a push or a pull that causes change in magnitude and/or direction of velocity.

A point particle is an object represented as a point, even though it is a rigid body.

A free body diagram shows the different forces acting on a body using arrows.

2.2.1 Newton's laws of motion

The most important work on forces has been done by Isaac Newton, who developed three laws describing how forces act:

Newton's 1st law

If the net force F on an object is zero then its velocity v is constant:

$$F_{\text{net}} = 0 \quad \Rightarrow \quad a = 0 \quad \Rightarrow \quad \Delta v = 0$$

Newton's 2nd law

The net force F of an object is equal to its mass m times its acceleration a :

$$F_{\text{net}} = ma$$

DB 2.2

Newton's 3rd law

Every action has an equal but opposite reaction:

$$\vec{F}_a = -\vec{F}_b$$

How do you solve a problem involving forces?

1. Draw a free body diagram and label the forces appropriately
 - Drag forces act opposite to the direction of motion
 - Reaction force/normal force acts perpendicular to the surface
2. Resolve forces if necessary
3. Check Newton’s first law: is the *net force* or *resulting force* F_{net} zero?

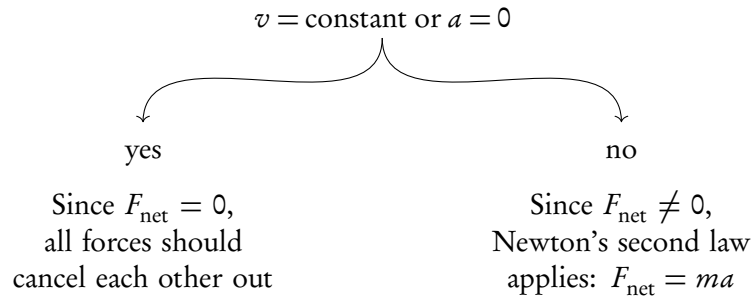

Example.

A crate with a mass of 50 kg stands on a 20° slope. A rope is tied to the crate to keep it in place. Find the tension in the rope.

1. Draw a free body diagram

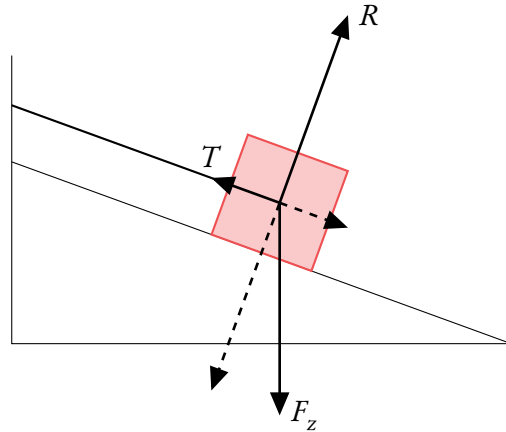

There are three forces acting on the crate: its weight F_z , the resultant force R , and the tension T in the rope.

2. Resolve vectors

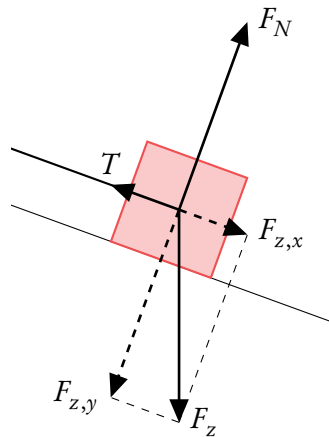

We can resolve F_z so that its components align with the other vectors.

3. Is the net force zero?

Because the crate does not move, its velocity is 0, which is constant. The net force must be 0. All forces should cancel each other out. This means force T is equal to $F_{z,x}$.

$$F_z = mg = 50 \cdot 9.81 = 490.5 \text{ N}$$

$$\sin 20^\circ = \frac{F_{z,x}}{F_z}$$

$$F_{z,x} = F_z \sin 20^\circ = 490.5 \sin 20^\circ = 168 \text{ N}$$

$$T = F_{z,x} \approx 1.7 \times 10^2 \text{ N}$$

2.2.2 Solid friction

Try pushing a crate: it can be difficult to get going, but once the crate starts moving it becomes easier. This is because you have to overcome static friction, which is bigger than dynamic friction. Once you're pushing the crate forward, you experience dynamic friction. The heavier the crate, the more friction there is. For the exam, you should be able to calculate both types of friction.

Static friction: $F_f \leq \mu_s R$

Dynamic friction: $F_f = \mu_d R$

R = normal reaction force

μ_s = coefficient of static friction

μ_d = coefficient of dynamic friction

An ice skater going 8.0 m/s stops skating. After 34 m she comes to a complete stop. What is the coefficient of dynamic friction?

Since the friction force is the only force acting on the skater, $F_f = F_{\text{net}}$, which means

$$\mu_d R = ma$$

and because the skater is on a flat surface, R is equal to the weight of the skater, mg :

$$\mu_d mg = ma$$

$$\mu_d = \frac{a}{g}$$

To determine the acceleration, we can use the initial speed, final speed, and distance given:

$$v^2 = u^2 + 2as$$

$$0 = 8.0^2 + 2 \cdot a \cdot 34$$

$$a = -0.94 \text{ m/s}^2$$

$$\mu_d = \frac{0.94}{9.81} \approx 0.10$$

2.3 Work, energy and power

Energy comes in many different forms, but is always conserved. This is one of the most fundamental laws of physics. In this section we'll take a closer look at conservation, transformation, and various types of energy.

2.3.1 Conservation of energy



The principle of conservation of energy states that in any closed system, the total amount of energy will always stay the same: $E_1 = E_2$.

DB 2.3 The total energy at a certain point can consist of different types of energy:

Kinetic energy	$E_k = \frac{1}{2}mv^2$	E = energy [J] Δb = difference in height [m] k = spring constant Δx = difference in displacement [m]
Gravitational potential energy	$E_g = mg\Delta b$	
Elastic potential energy	$E_e = \frac{1}{2}k\Delta x^2$	

Example.

Bryan dives off a 10 m high cliff. With what velocity does he hit the water?

$$E_1 = E_g = mgh$$

$$E_2 = E_k = \frac{1}{2}mv^2$$

$$E_1 = E_2$$

$$mgh = \frac{1}{2}mv^2$$

$$v = \sqrt{2gh}$$

$$v = \sqrt{2 \cdot 9.81 \cdot 10} \approx 14 \text{ m/s}$$

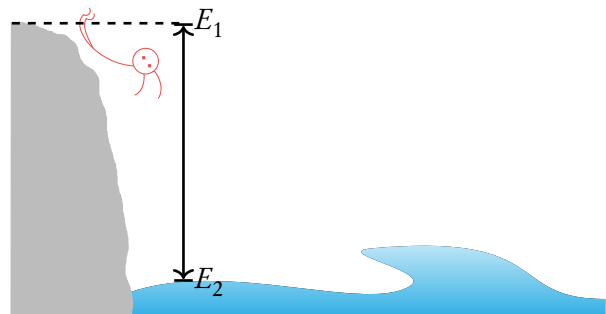

2.3.2 Work

Work is used to transfer energy from one point to another or from one form to another.



Work is equal to:

1. the amount of force exerted in the direction of motion:

$$W = F s \cos \vartheta$$

W	=	work	[J]
F	=	force	[N]
s	=	distance	[m]

2. the change in (potential, kinetic, and friction) energy between two points, ΔE . An example of this is given below.

DB 2.3

Example.

I move a 5 kg box onto a shelf, 2 m from the floor. What is the work done?

The work done is equal to the change in energy:

$$W = m g h_2 - m g h_1 = 5 \cdot 9.81 \cdot 2 - 5 \cdot 9.81 \cdot 0 \approx 98 \text{ J}$$

But if work is the change in potential energy, what about the conservation principle?

Work is just a specific type of energy, done by muscles (like in the example above) or an engine, for example. That's why its unit is also joule. So in the previous above, $W = E_g$, and the total amount of energy is still conserved.

Force-distance graphs

In the IB, you're quite likely to get a force-distance graph from which you have to determine the work done. When this is the case, remember that work is the area under the curve, because work is equal to force times distance.

2.3.3 Power

Suppose you want to buy a car: you'd be interested in how well the engine works. But a car that drives 100 km in an hour and a car that drives 100 km in 5 hours both have delivered the same amount of energy. You want to know how much energy the engine can deliver within a specific time — you want to know the power.

DB 2.3

Power is the rate of energy transfer: the energy change over a certain period of time. It is also equal to the force times the velocity:

$$P = \frac{\Delta E}{\Delta t} = Fv$$

P = power [J/s]
 ΔE = difference in energy [J]

DB 2.3

Back to your new car: if the engine has a lot of power, but half of the power is used to produce heat, it's not a very efficient engine.

$$\text{Efficiency} = \frac{\text{useful work}}{\text{total work}} \cdot 100\% = \frac{\text{useful power}}{\text{total power}} \cdot 100\%$$

2.4 Momentum and impulse

Momentum is what gives objects their force. Does a book landing on your toes hurt? It depends on whether someone drops it, or smashes it on the ground - velocity plays an important role. Also, the heavier the book, the more pain you'll be in. This is reflected in the formula for momentum.

DB 2.4

Momentum is the mass of an object times its velocity: $\vec{p} = m\vec{v}$



As was stated above, momentum has a close relation with force. Rewriting Newton's second law gives:

$$F = ma = m \frac{\Delta v}{\Delta t} = \frac{\Delta p}{\Delta t}$$

meaning force is equal to the rate of change of momentum. *Note:* this is only true if the mass is constant.

DB 2.4

Impulse is the change in momentum of an object: $\Delta p = F\Delta t$



Force-time graphs

When given a force-time graph, you can calculate the maximum force, or the impulse. Use the formula for impulse, $\Delta p = F \Delta t$, and data from the graph to get to the answer.



The law of conservation of momentum says that when the external force on a system is zero, $F_{\text{ext}} = 0$, momentum is conserved.

The concept of conservation of momentum is especially useful when it comes to collisions. There are two types of collisions:



Elastic collisions where both momentum and kinetic energy are conserved

Inelastic collisions where momentum is conserved, but kinetic energy is not

Two objects colliding and then sticking together is an example of an inelastic collision. In that case,

$$m_1 v_1 + m_2 v_2 = (m_1 + m_2) v_3$$

For your exam, it's important that you understand the concepts and definitions given above, especially how force is related to momentum and impulse. Make sure you're comfortable using these definitions in an argument, as is necessary in the following examples.

Example.

Explain why a flexible safety net is less harmful for an incoming skier than a rigid barrier.

A force F is proportional to the rate of change of momentum, $F = \frac{\Delta p}{\Delta t}$. Using a safety net, the change in momentum is less sudden compared to using a rigid barrier, meaning the skier experiences less force.

Example.

A moving ball collides with a stationary ball on a frictionless surface, which results in a complete stop of the first ball. It is known that the first ball has mass 1 kg, the second ball has mass 2 kg and the initial speed of the first ball is 20 m/s. Find the final speed of the second ball and identify whether this collision was elastic or inelastic.

Using the law of conservation of momentum, we get that $m_1v_1 + m_2v_2 = m_1v_3 + m_2v_4$. From the question we know that $v_2 = 0$ and $v_3 = 0$, thus $m_1v_1 = m_2v_4$. Giving an answer of: $v_4 = \frac{1 \cdot 20}{2} = 10 \text{ m/s}$.

To check whether the collision was elastic or inelastic, we need to compare kinetic energies before and after collision:

$$\text{Kinetic energy before: } \frac{1}{2} \cdot 1 \cdot 20^2 = 200 \text{ J}$$

$$\text{Kinetic energy after: } \frac{1}{2} \cdot 2 \cdot 10^2 = 100 \text{ J}$$

Since there was a loss of kinetic energy, the collision is inelastic.

THERMAL PHYSICS

■	3.1. Thermal concepts	32
■	3.2. Phase transitions	34
■	3.3. Kinetic model of an ideal gas	37

3.1 Thermal concepts

3.1.1 Temperature, heat and internal energy



Temperature is a measure of how hot something is, or a measure of the average kinetic energy of molecules. It is given in celsius or kelvin:

$$K = ^\circ C + 273$$

That is, melting ice is 0°C or 273 K . When using an equation that contains the temperature T , *always fill in the temperature in kelvin*.

Heat is the amount of energy transferred from a warmer to a cooler object and is measured in joule (J).

Internal energy of an object is the sum of all kinetic energy of its molecules plus the intermolecular potential energy. It is measured in joule (J).

Mind that internal energy is about the molecules, and not about the energy of the body as a whole (the types of energy discussed in the mechanics chapter).

Heating or cooling a system changes the internal energy, so that one of two things may happen:

- A change in kinetic energy will change the temperature of the system
- A change in potential energy will change the phase of the system

We'll take a closer look at phase transitions further on in the chapter.

3.1.2 The mole

The mole is used to quantify large amounts of molecules. Just as we use a dozen to say we have 12 of something, we can use a mole to say we have 6.02×10^{23} of something.

This specific number is called the **Avogadro constant**, N_A .



Mole when there are 6.02×10^{23} molecules of something, it is equal to one mole. The mole is the SI unit for measuring the amount of a substance.

Molar mass the mass of one mole of a substance.

To figure out the number of moles, use

$$n = \frac{N}{N_A}$$

n = number of moles
 N = number of molecules
 N_A = Avogadro constant 6.02×10^{23}

Example.

A room is filled with exactly 8.00×10^{23} oxygen molecules. This is

$$n = \frac{N}{N_A} = \frac{8.00 \times 10^{23}}{6.02 \times 10^{23}} \simeq 1.33 \text{ mol}$$

3.2 Phase transitions

3.2.1 Molecular theory

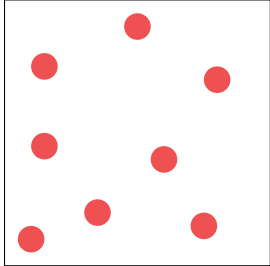
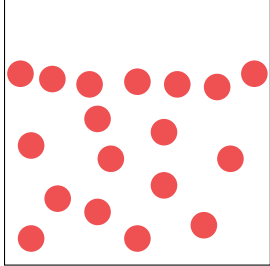
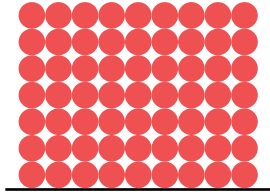
Phase	Intermolecular forces		
Gas	Molecules are far apart	low for ideal gasses: negligible	
Liquid	Molecules are closer together	bigger	
Solid	Molecules are packed together very closely, sometimes in a crystal as in the picture	large	



Intermolecular bonds are bonds that hold molecules together. According to the molecular theory, a phase transition means the bonds get stronger or weaker.

3.2.2 Specific heat capacity and specific latent heat

A phase transition means a substance changes from one phase to the other, e.g., ice melting to water.

There are two important concepts you need to remember when working with phase transitions:



Specific heat capacity c the energy needed to warm up 1 kg of matter by 1°C .

$$Q = mc\Delta T$$

Q = total heat [J]
 m = mass [kg]
 ΔT = change in temperature [K]

Specific latent heat L energy needed for 1 kg of matter to go through a phase transition. During this process, the temperature stays constant.

$$Q = mL$$

Apart from using these concepts in a formula, you should be able to tell something about them using a graph.

3.2.3 Temperature graphs

There are two types of graphs you can expect on your exam: temperature-energy graphs and temperature-time graphs. You're expected to understand and extract information from them. Most of the graphs on the IB will look like the one below, showing a phase transition.

Specific heat capacity

Check the slope.

The specific heat capacity *differs per phase* when power is supplied at a constant rate. The steeper the slope, the smaller the specific heat capacity. In this case, the specific heat capacity for gas (c_g) is bigger than for liquid ($c_l > c_l$): c_l .

Specific latent heat

Check the horizontal line.

This is where the phase transition takes place, because the temperature stays constant. The latent heat *differs per phase transition*. The broader the line, the more latent heat is needed for a phase transition.

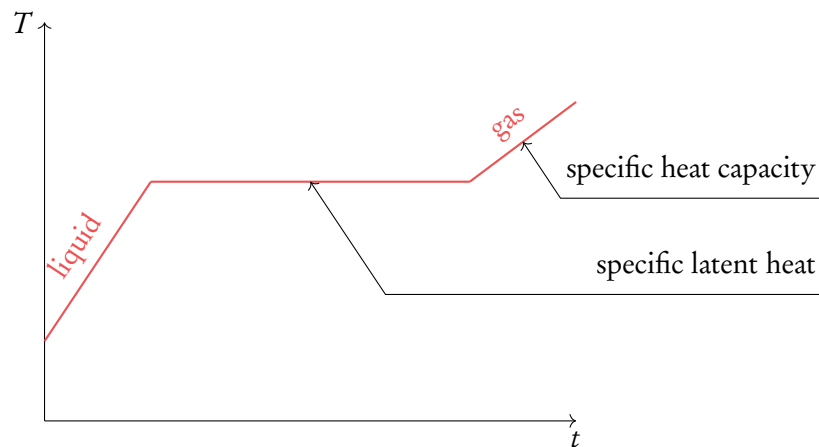

3.3 Kinetic model of an ideal gas

Physicists have developed a model to represent ideal gases. This model makes a couple of assumptions and it is only an accurate representation under specific circumstances, but it gives scientists a good understanding of how gases work.

3.3.1 Assumptions

The following assumptions are made when dealing with ideal gases. You can remember them by using the acronym NITES.

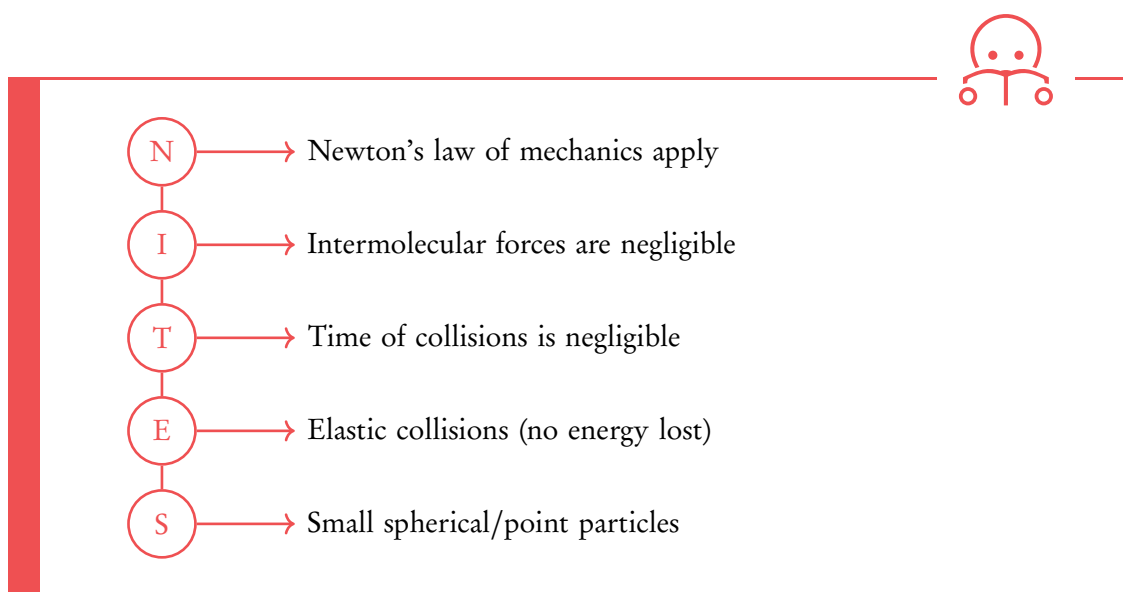

Under which circumstances is the ideal gas model an accurate representation of a real gas?
When the real gas is spread out as much as possible. The air in a living room is a good example, as it has

low pressure – high temperature – low density – large volume

When one of these conditions differ, for example when all the air is put in a very small container, the ideal gas model is no longer accurate.

3.3.2 Pressure

Pressure is an important concept when it comes to gases, so here we'll look at it in two different ways: macroscopic and microscopic.

Macroscopic

On a regular scale, pressure is equal to the force applied per area:

$$p = \frac{F}{A}$$

p	= pressure	$[\text{N m}^{-2}]$ or $[\text{Pa}]$
F	= force	$[\text{N}]$
A	= area	$[\text{m}^2]$

This is why somebody in high heels may do damage to a floor, but someone on flip-flops may not: in the first case, the same amount of force is divided over a very small area, resulting in a much higher pressure.

Microscopic

On the molecular scale, the pressure of a gas indicates how often molecules are bumping into the sides of a container (in which case the molecules are also applying a force to an area). The more they bump, the higher the pressure. Putting in more molecules or making the molecules go faster results in more bumping.

3.3.3 The ideal gas law

The equation that describes the ideal gas model is

$$pV = nRT$$

p	= pressure	$[\text{N m}^{-2}]$ or $[\text{Pa}]$
V	= volume	$[\text{m}^3]$
n	= amount of substance	$[\text{mol}]$
R	= ideal gas constant:	$8.314 \text{ J K}^{-1} \text{ mol}^{-1}$
T	= temperature	$[\text{K}]$

This equation shows how an ideal gas behaves. For example, when the temperature of a gas in a container becomes twice as large, the pressure will become twice as large too (since the volume can't change). Make sure you understand the relation between all the variables, as the example given in the previous sentence is a common IB question.

From this ideal gas law, there are a few other laws we can derive:

- pressure-volume law, or Boyle's law
- volume-temperature law, or Charles' law
- pressure-temperature law, or Gay-Lussac's law

Pressure-volume law

When the temperature T is constant, the right side of the ideal gas law is constant.

This means the left side of the equation has to be constant, too:

$$pV = \text{constant}$$

Volume-temperature law

When the pressure p is constant, we can change the volume V , but that means that the temperature T will be changed in the same way to make sure both sides remain equal:

$$\frac{V}{T} = \text{constant}$$

Pressure-temperature law

Similarly, when the volume is held constant,

$$\frac{p}{T} = \text{constant}$$

3.3.4 Kinetic energy

It is important to know that the average kinetic energy of a gas is proportional to the temperature: when the kinetic energy doubles, so does the temperature, although this does not happen instantly – you might have to wait a few minutes. This is reflected by the equation

$$E_k = \frac{3}{2}k_B T = \frac{3}{2} \frac{R}{N_A} T$$

where k_B is the Boltzmann constant. Don't worry too much about how to use this formula, the most important thing to notice here is that the average kinetic energy E_k and temperature T are proportional.

OSCILLATIONS AND WAVES



4.1. Oscillations	42
4.2. Travelling waves	44
4.3. Wave characteristics	46
4.4. Interference	50
4.5. Standing waves	52

4.1 Oscillations

4.1.1 Wave properties



Equilibrium

The position where no forces act on the object.

Displacement (x)

The distance from the equilibrium.

Amplitude (A)

The maximum value the oscillation can have.

Period (T)

The amount of time it takes to complete a full oscillation.

Frequency (f)

The amount of periods per second.

The period T and frequency f of a wave are linked by $T = \frac{1}{f}$.

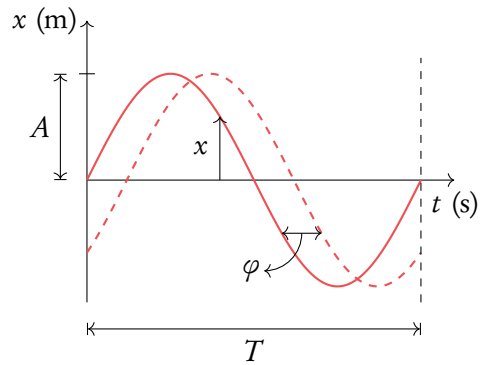

When comparing two oscillations, the phase (φ) difference becomes important. When the oscillations start at the same point, they are in phase. However, when one has already completed half an oscillation before the other starts, they differ half a phase. You can see this on the images on the right.

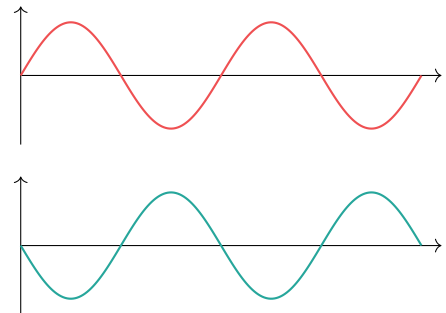

4.1.2 Simple harmonic motion

In the IB, two types of harmonic motion may appear: a pendulum (a ball on a string), or a block attached to a spring.

For *simple harmonic motion*, the acceleration is opposite to the displacement: $a \propto -x$.

We can see this when looking at pendulum. When the pendulum moves to the right, gravity tries to pull it back to its equilibrium and therefore works the opposite way. If you look at the graphs, you can see that this is equal to a and x differing *half a phase*.

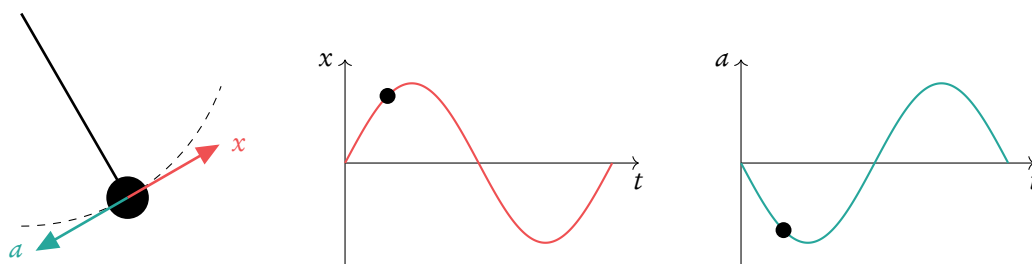

Additionally, velocity v and acceleration a differ *a quarter of a phase*. This is because when v is maximum, it does no longer accelerate and therefore a is zero. It is because velocity is a derivative of displacement and acceleration is derivative of velocity, as seen on the graphs below.

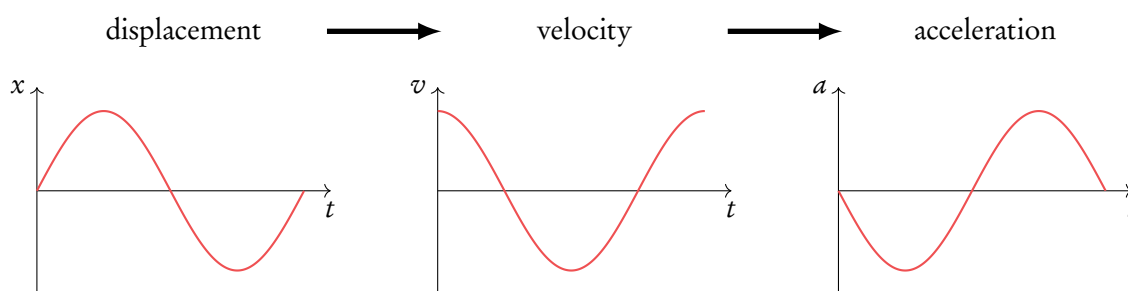

4.2 Travelling waves

Whereas oscillating things only move from one side to the other, waves can propagate. We call these travelling waves (as opposed to standing waves, which will be discussed at the end of this chapter). A standing wave has all the properties listed for oscillations, but it also has a **wavelength** (λ): the distance before a wave starts repeating itself.

4.2.1 Transversal and longitudinal waves

Within the category of travelling waves, we distinguish two types of waves.

For **transverse waves**, the displacement of particles is *perpendicular* to the wave movement.

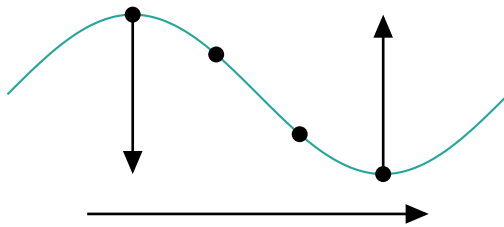

A wave in the water is a good example of this: each particle just goes up and down (oscillates), but this results in a wave that moves to the right.

For **longitudinal waves**, the displacement of the particles is *parallel* to the wave movement. Sound waves are longitudinal waves.

It's what you get when putting a spring on the table and moving it back and forth, as depicted below. Again, the particles just move back and forth, but the wave can propagate along the spring. As you can see, there are places with a high density: these are **compressions**. Areas with a low density are **rarefactions**.



4.2.2 Graphs of longitudinal waves

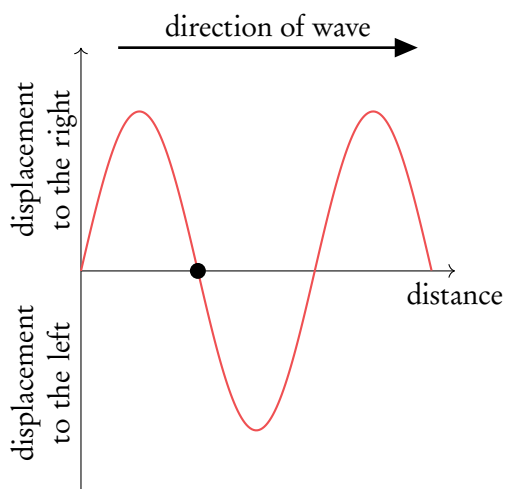

On the IB, you should be able to locate points of compression or rarefaction in a displacement-distance graph. Such a graph shows the distance a wave has covered on the x -axis and the displacement of each particle on the y -axis. Points above the x -axis move to the right, while points below the x -axis move to the left. At the black dot, particles left of the dot move to the right, and particles right of the dot move to the left, which means it is a point of compression.

4.2.3 Electromagnetic waves

Light is also a wave: an electromagnetic wave. Unlike the wave in the water or in the spring, electromagnetic waves don't need a medium to propagate.

There are many more types of electromagnetic waves. Below you can find them in order of magnitude, with the shortest waves on the left side.

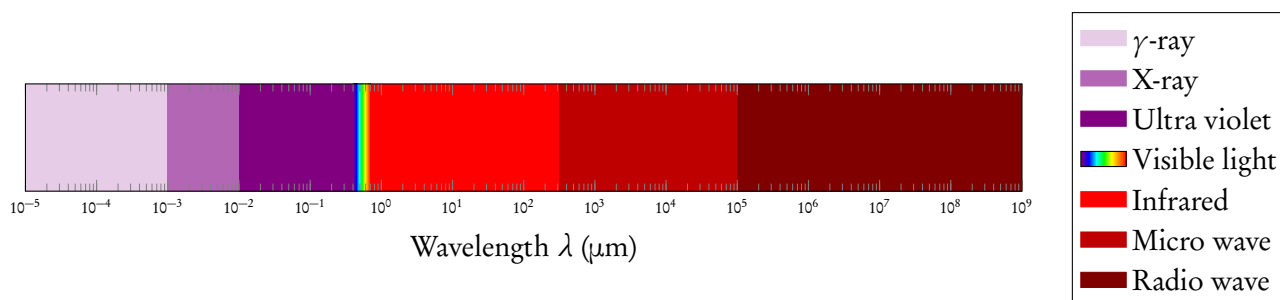

All of these waves travel with the same speed. But as their wavelengths can vary, so can their frequency. To calculate this, you can use

$$c = f \lambda$$

- c = speed of light [m/s]
- f = frequency [Hz]
- λ = wavelength [m]

4.3 Wave characteristics

Travelling waves have certain characteristics you should be aware of. These include polarization, reflection, refraction, and diffraction, all treated in this section, and interference, which is treated in the next section. All of these characteristics apply to electromagnetic waves. The same goes for sound waves, with the exception of polarization.

4.3.1 Intensity

Every wave has a certain intensity I . Think of music: you hear it best when you are close to the speaker, or when you turn up the volume. Intensity is therefore related to the distance travelled as well as its amplitude (which determines volume):

$$I \propto x^{-2}$$

$$I \propto A^2$$

$$I = \text{intensity} \quad [\text{W/m}^2]$$

$$x = \text{distance travelled} \quad [\text{m}]$$

$$A = \text{amplitude} \quad [\text{m}]$$

Example.

You are listening to your favourite artist two meters away from the speaker. You walk to the kitchen, another 2 meters away, to grab a snack. *What is the intensity of the sound waves in the kitchen with respect to your former position?*

You double your distance to the speaker. Since $I \propto x^{-2}$, doubling the distance means a decrease in intensity of $2^{-2} = \frac{1}{4}$, only a quarter of the former intensity.

4.3.2 Polarization

Polarization is a property of transverse waves (so it does not occur with sound waves!). It specifies the orientation of the oscillations. For example, we can pluck a guitar string by pulling it upwards and then letting go, and it will oscillate vertically. But we can also pluck it sideways, and it will start oscillating horizontally. Unpolarized light oscillates in all directions, but we can filter certain directions using polarizing filters.

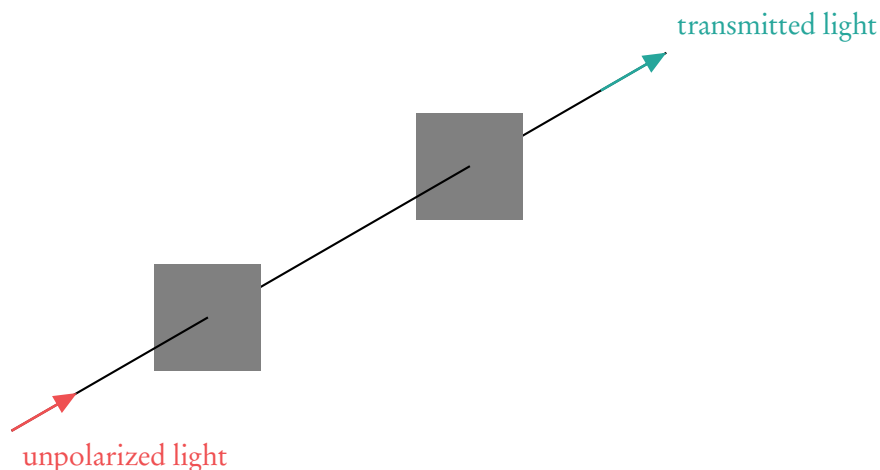

On the IB, you are likely to get a question involving two polarizing filters. When these filters are parallel, e.g. both only let through horizontally polarized light, the second filter doesn't have any effect. But when the first only lets through horizontally polarized light and the second only vertically polarized light, the result is that all light is blocked. The position of these filters relative to each other therefore determines how much light is transmitted. You can calculate this using Malus's law:

$$I = I_0 \cos^2(\vartheta)$$

	I_0 = intensity after the first filter	$[\text{W}/\text{m}^2]$
	I = intensity after the second filter	$[\text{W}/\text{m}^2]$
	ϑ = difference in angle between two filters	

When the filters are parallel, $\vartheta = 0^\circ$, and the cosine reduces to 1: the intensity stays the same, just as we expected. When $\vartheta = 90^\circ$, the cosine becomes 0, and all light is blocked.

4.3.3 Refraction, reflection, diffraction

Refraction

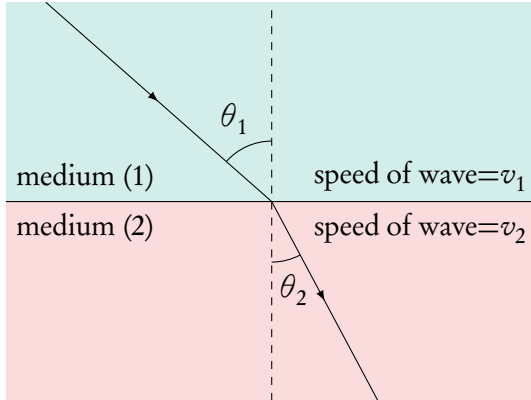

Have you ever looked through a glass of water and noticed everything gets a totally different shape? This is because waves bend when going from one medium to another (from air to water, for example).

This is called refraction, and it is described by Snell's law:

$$\frac{n_1}{n_2} = \frac{\sin \vartheta_2}{\sin \vartheta_1} = \frac{v_2}{v_1}$$

n = refractive index
 ϑ = angle of refraction
 v = velocity of light in the medium [m/s]

Reflection

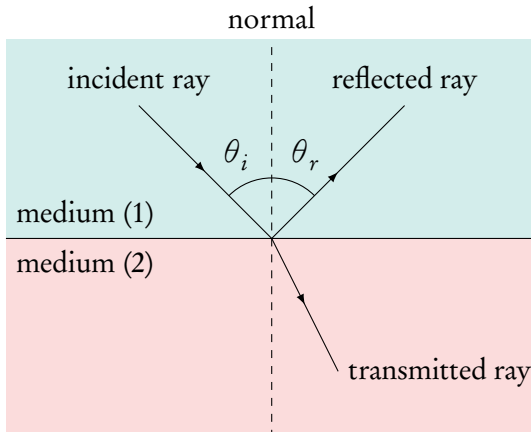

When a wave goes from one medium to another, part of the wave can reflect, for example off a window or the surface of a lake. The angle at which the light is reflected is equal to the incident angle: $\vartheta_i = \vartheta_r$.

Diffraction

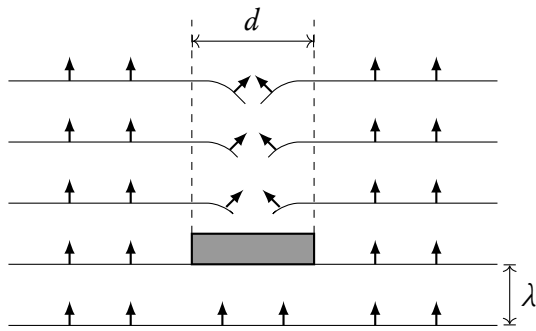

When waves in water meet a rock, they will have to move around it, which results in the pattern to the left. This is called diffraction. It only occurs when the disturbance is of the same order of magnitude as the wavelength, and does not alter any properties of the wave.

Critical angle

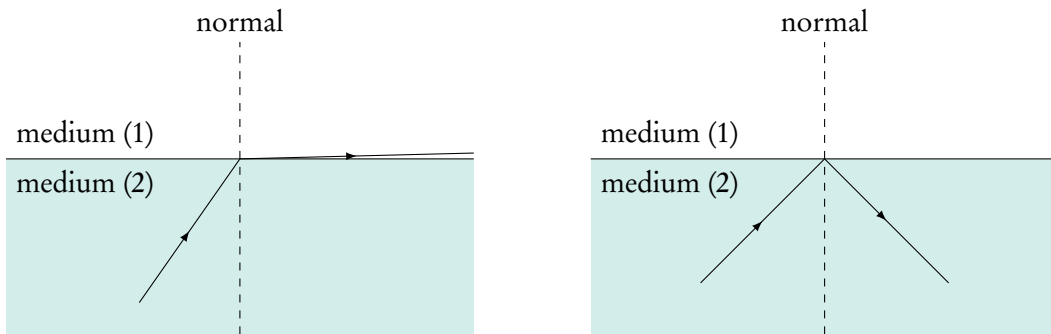

When a wave hits the new medium at or bigger than a critical angle, no wave will be refracted. Then the wave will be fully reflected back. To find the critical angle, use Snell's law with refracted angle equal to 90° and solve for the other angle:

$$\theta_{\text{crit}} = \arcsin\left(\frac{n_2}{n_1}\right)$$

Note, that a critical angle exists only if $\frac{n_2}{n_1}$ is less than 1.

4.4 Interference

It is possible to add up or subtract two waves. To do this, the waves must be **coherent**: they should have the same frequency and a constant phase difference. On your exam, waves will always be coherent.

The possibility of adding or subtracting waves is called the **superposition principle**: the total displacement is the sum of the displacement of each wave. This can result in constructive and destructive interference.

Destructive interference

$$\left(n + \frac{1}{2}\right) \lambda = \text{path difference}$$

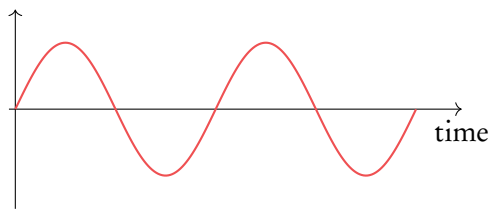

+

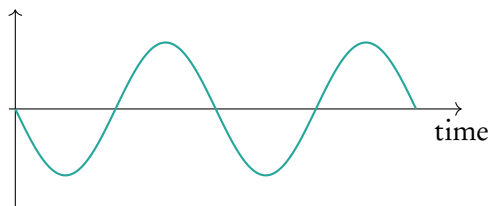

=

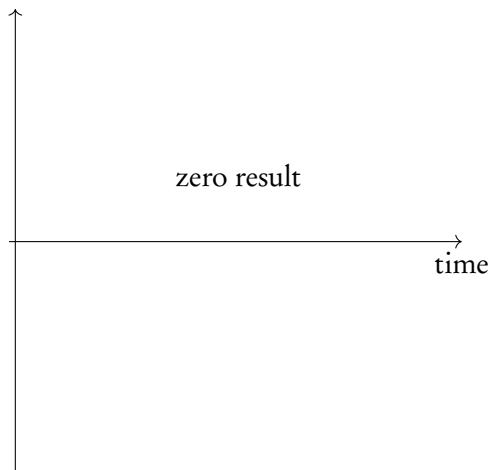

Constructive interference

$$n \lambda = \text{path difference}$$

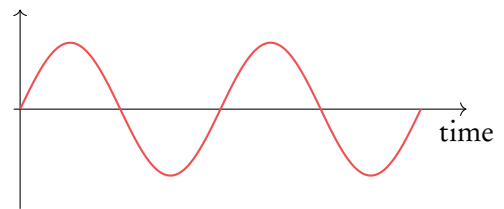

+

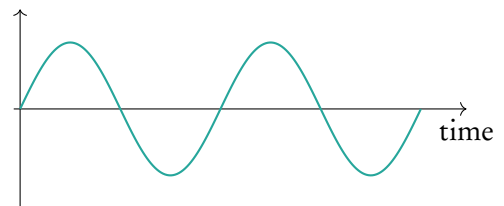

=

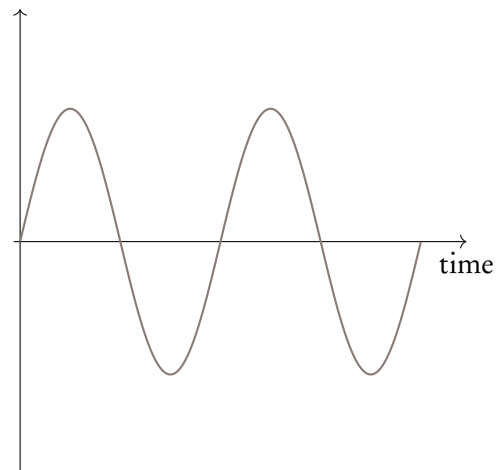

4.4.1 Double slit interference

If we would send a wavefront through two slits, the waves from each slit will start to interfere. When we put a screen some distance from the slits, we could see an interference pattern: light fringes at points where waves add up (maxima), dark fringes at points where they subtract (minima).

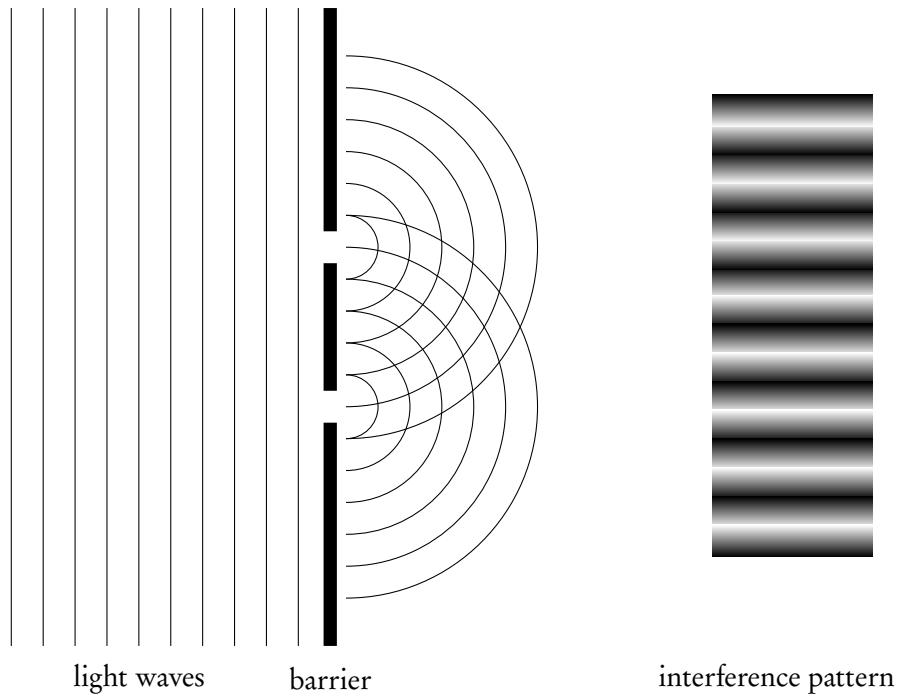

The spacing of these fringes depend on multiple things, as shown in the formula below. Make sure you understand how these variables relate.

$$s = \frac{\lambda D}{d}$$

- s = spacing between maxima (or minima) [m]
- D = distance from barrier to screen [m]
- λ = wavelength [m]
- d = distance between slits [m]

4.5 Standing waves

Unlike travelling waves, standing waves don't move. On your exam, you'll encounter standing waves in ropes or tubes. These can have different boundaries:

- For ropes: a combination between fixed and free ends,
- For tubes: a combination between closed and open ends.

The types of ends determine the properties of the standing wave.

- On a fixed or closed end, there should *always* be a node.
- On a free or open end, there should *always* be an anti-node.

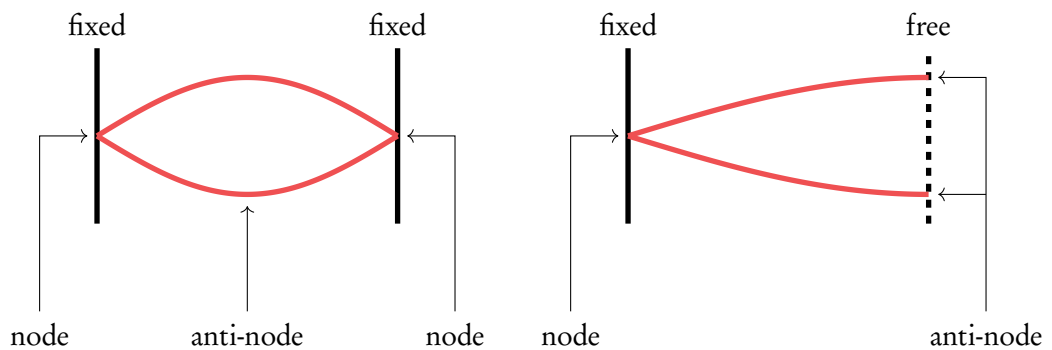

The standing waves depicted are **first harmonics**: they contain the least possible amount of nodes and anti-nodes.

We can put some more nodes and anti-nodes in there. These are also perfect standing waves; they're just not first harmonics.

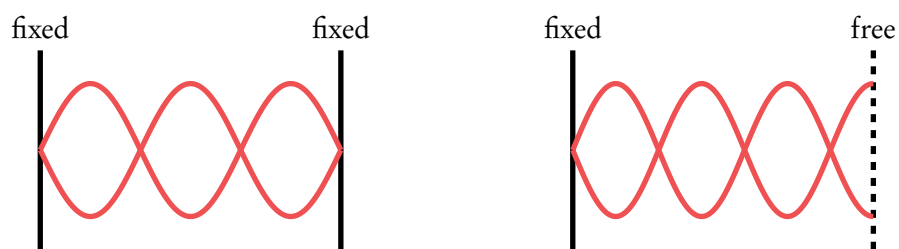

Example.

The standing wave in the left picture above has a frequency of 150 Hz. *What is the frequency of the wave in the right picture?*

The right wave has $1/6^{\text{th}}$ extra: $1\frac{1}{6} \times 150 = 175$ Hz.

However, it is also possible to find wavelength of a standing wave in open or closed pipes at different harmonics using the formulas below.

If there is a standing wave on a string or a sound wave in a pipe with both ends open, we get the following relationship between wavelength and a length of a string or a pipe:

$$\lambda = \frac{2L}{n}$$

λ = wavelength
 L = length of a string or a pipe
 n = the harmonic number

A similar relationship exists for a sound wave in a pipe with one open and one closed end. However, the harmonics can only be odd numbers in such a case:

$$\lambda = \frac{4L}{n}$$

λ = wavelength
 L = length of a string or a pipe
 n = the harmonic number, only odd numbers

ELECTRICITY AND MAGNETISM

5.1. Electric fields	56
5.2. Resistance	59
5.3. Cells	61
5.4. Magnetic effects of electric currents	64
5.5. Movement of a charged particle in a magnetic field	65

5.1 Electric fields

5.1.1 Charge

Charge is a property of matter that causes it to experience a force to other charged matter.

There are two types of charge: **positive** and **negative**. Like charges repel each other, while opposite charges attract.

The SI derived unit of charge is coulomb (C). Coulomb's law quantifies the force between two particles.

$$F = k \frac{q_1 q_2}{r^2}$$

F	= force	[N]
k	= Coulomb's constant	
q_1	= charge 1	[C]
q_2	= charge 2	[C]
r	= distance between charges	[m]

Coulomb's constant is defined as $k = \frac{1}{4\pi\epsilon_0}$, where ϵ is called the **permittivity**. ϵ_0 stands for the permittivity in vacuum, for which Coulomb's constant becomes $8.9875 \times 10^9 \text{ N m}^2 \text{ C}^{-2}$.

As you can see from Coulomb's law, the force between two particles strongly depends on the distance between them. When the distance decreases, the force will increase, as is shown in this figure (note: it is assumed that the particles q_a and q_b do not interact between each other).

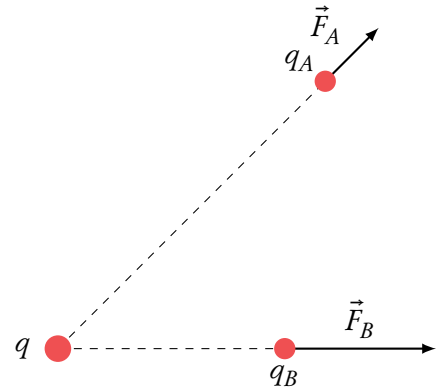

5.1.2 Nature of electric fields



Electric field is the electrostatic force on a stationary particle of unit charge 1 C.

$$E = \frac{F}{q}$$

E = electric field [N/C]

F = force [N]

q = charge [C]

Electric fields are caused by electric charges, and the strength of the field diminishes further away from its source. An electric field can be visualized by drawing field lines. This is shown below. The direction of the electric field is always from the positive to the negative charge.

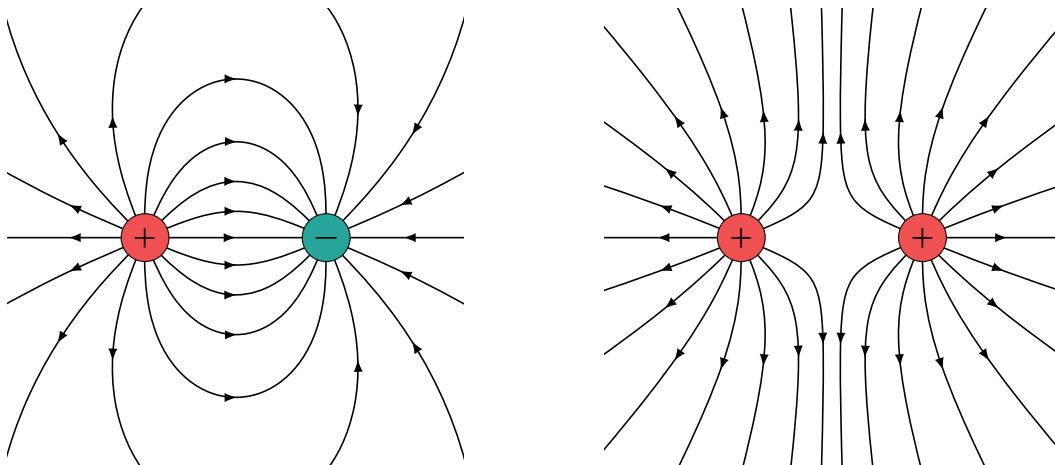

5.1.3 Voltage

When you throw a ball in the air, it works against the gravitational force and therefore gains potential (gravitational) energy. The same thing happens when, for example, a positive charge moves closer to another positive charge. It works against the electric force and therefore gains potential energy.



Voltage is the difference in electric potential energy of a charge that moves in an electric field per unit charge

$$V = \frac{W}{q}$$

V = voltage [V] or [J/C]
 W = work [J]
 q = charge [C]

Just like the ball in the air will fall and gain kinetic energy, a particle can transfer the work into kinetic energy and gain speed.



Electronvolt (eV) is the amount of work needed to change the electric potential of an electron by 1 V.
 It's a unit of energy: $1 \text{ eV} = 1.602 \times 10^{-19} \text{ J}$.
 You can therefore calculate the work in joule or in electronvolt.

5.1.4 Current



Current is the amount of charge that flows per unit time. Its unit is ampere (A).

$$I = \frac{\Delta q}{\Delta t}$$

I = current [A]
 Δq = amount of charge [C]
 Δt = change in time [s]

The charge of one electron is labeled e . So, when electrons move through a wire, the amount of charge Δq is equal to e times the number of electrons. By convention, when electrons are flowing to the *right*, the current is flowing to the *left* (which is a bit confusing).

It is also possible to calculate the current using the *drift velocity*, which is the average velocity an electron has in a wire.

$$I = nAvq$$

I = current [A]
 n = number of charge carriers per unit volume [m^{-3}]
 A = cross section of a wire [m^2]
 v = drift velocity [m/s]
 q = charge [C]

Current constantly flowing through a wire in one direction is called **direct current (DC)**.

5.2 Resistance

5.2.1 Circuits

An electric circuit consists of

- A cell that provides voltage, labeled with E or V .
- Resistors, which have a certain resistance. This tells how difficult it is for current to pass. The higher the resistance, the more difficult it is for current to flow. Resistors are labeled with R .
- Wires that connect all elements in the circuit. For wires in circuits, you can assume resistance is zero.
- Anything else you can find under ‘electrical circuit symbols’ in your data booklet.

We will now look at how circuits work, and how you can calculate the voltage, current and resistance for each element in the circuit.

Ohm’s law

Ohm’s law enables you to calculate the resistance, which tells how difficult it is for current to pass. The higher the resistance, the more difficult it is for current to flow. The unit of resistance is ohm (Ω)

$$R = \frac{V}{I}$$

R	=	resistance	[Ω]
V	=	voltage	[V]
I	=	current	[A]

Kirchhoffs’ laws

To find out how voltage and current divide themselves over a circuit, use Kirchhoff’s laws:

- **Loop:** $\sum V = 0$

In a loop, the sum of all voltages is equal to zero. The voltage of the cell and the voltages across the circuit have opposite signs.

- **Junction:** $\sum I = 0$

On a junction, the sum of all currents is equal to zero. Currents flowing in and currents flowing out have opposite signs.

Example.

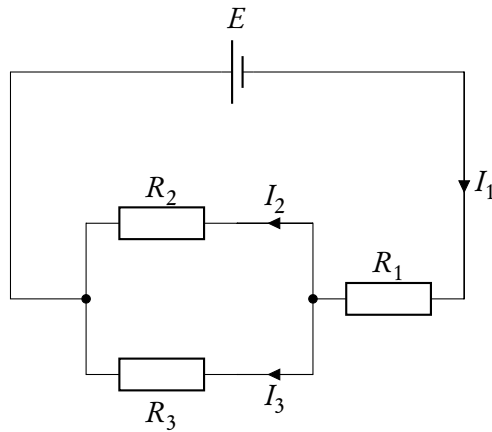

For the outer loop:

$$\sum V = E + I_1 R_1 + I_3 R_3 = 0.$$

So that

$$-E = I_1 R_1 + I_3 R_3.$$

For the first junction:

$$\sum I = I_1 - I_2 - I_3 = 0.$$

So that $I_1 = I_2 + I_3$.

As you can see in the circuit in the example above, there are two possible ways to arrange resistors. The total resistance (R_{tot}) of the resistors combined depends on their arrangement.

Series

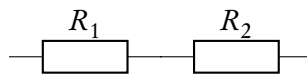

$$R_{\text{tot}} = R_1 + R_2 + \dots$$

Parallel

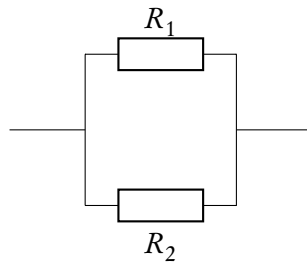

$$\frac{1}{R_{\text{tot}}} = \frac{1}{R_1} + \frac{1}{R_2} + \dots$$

Ammeters and voltmeters

Ammeter

Measures the amount of current at a certain point in the circuit.

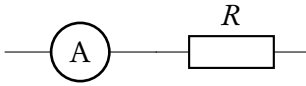

They are placed at the point where you want to measure the current.
An ideal ammeter has zero resistance, so that it doesn't slow the current.
In practice, however, ammeters are non-ideal and have a constant but nonzero resistance.

Voltmeter

Measures the amount of voltage over a certain point in the circuit.

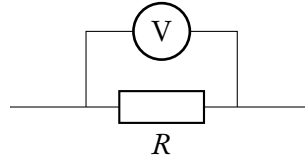

They are placed over the point where you want to measure the voltage.
The ideal voltmeter has an infinite resistance so that no current passes through the meter.
In practice, voltmeters are non-ideal and have a constant but finite resistance.

Power dissipation

If current is flowing through an element with resistance, this causes the element to heat up.

This means some energy is lost to heat. The rate at which energy is dissipated is the power dissipation:

$$P = VI = I^2R = \frac{V^2}{R}$$

P = power [W]
 R = resistance [Ω]
 V = voltage [V]
 I = current [A]

5.2.2 Resistance of a wire

As has been said before, you can neglect the resistance of wires in a circuit. But if the exam question specifically requires you to calculate the resistance of a wire, you can use

$$\rho = \frac{RA}{L}$$

ρ = resistivity [Ωm]
 R = resistance [Ω]
 A = cross section of a wire [m^2]
 L = length of wire [m]

The resistance depends on the material the wire is made of. Therefore, the formula includes resistivity ρ , which differs per material. The right value for resistivity will be included in the exam question.

5.3 Cells

A cell provides voltage for the circuit. A battery is an example of a cell. In this section, we'll go over the general properties of cells, as well as how they work in circuits.

There are two types of cells:

1. Primary cells that are discarded after their use, such as batteries
2. Secondary cells that can be recharged.

Terminal voltage

Every cell has a terminal voltage (or terminal potential difference) that tells how much energy the cell still has. When a cell is fully charged, it has a maximum terminal voltage, for example 12 V.

When the cell discharges, it loses its initial value quickly, but has a stable value for most of the time. At the end, the terminal voltage drops rapidly to zero.

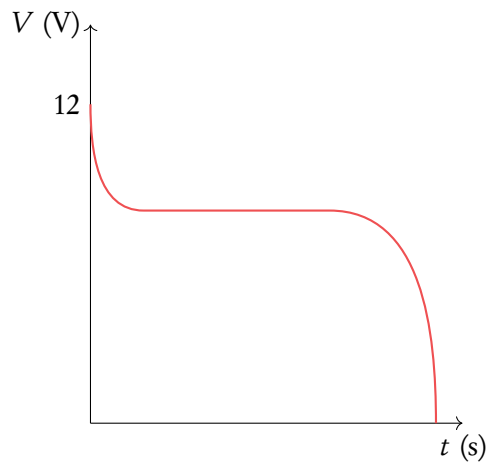

Internal resistance and emf

A cell has a small internal resistance, which means not all the terminal voltage can be transferred to the circuit. Some of it is used by the internal resistance. The actual output voltage of the cell is called the **electromotive force (emf)**, denoted by ε , and given by

$$\varepsilon = I(R + r)$$

ε = electromotive force [V]
 I = current [A]
 R = resistance [Ω]
 r = internal resistance [Ω]

V/I-diagrams

The internal resistance of a cell might be useful to know. In order to find this out, we can use this circuit, with a cell and a variable resistor. We can measure the current through and voltage over the variable resistor and plot it. This will result in a V/I-diagram.

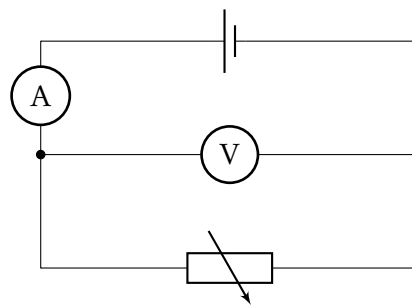

When we take the formula for electromotive force and rewrite it using $V = IR$, we get

$$\begin{aligned}\varepsilon &= V + Ir \\ V &= \varepsilon - Ir\end{aligned}$$

And there we have our formula for the line you see in the graph. *Does it remind you of $y = ax + b$?*

This means ε is the intercept with the y -axis, and r is the gradient. So whenever you're asked to calculate the internal resistance of a cell based on a V/I-diagram, go for the gradient.

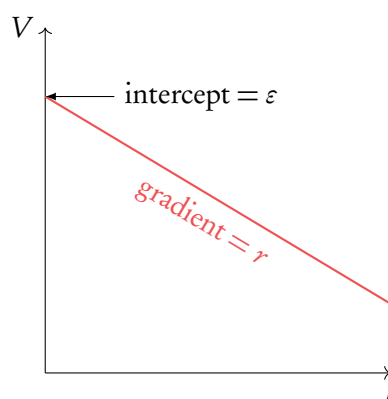

When you see a V/I-diagram with a curved line, it means the resistance you measured over is **non-ohmic**. As opposed to *ohmic resistances*, these do not follow Ohm's law. An example of an ohmic resistance is a wire, an example of a non-ohmic resistance is a filament lamp.

Be careful: sometimes the IB will switch the axes and give you an I/V-diagram. Don't let this confuse you!

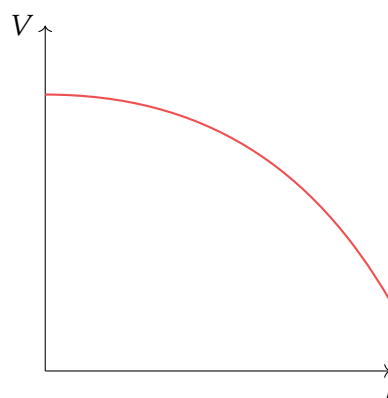

5.4 Magnetic effects of electric currents

Moving charges create a magnetic field. This means that a current-carrying wire is surrounded by its own magnetic field. To find out the direction of the magnetic field, use the right-hand rule: put your thumb in the direction of the current, and your fingers will curl in the direction of the magnetic field. Be aware that when *the current flows up, electrons go down*.

A charge or wire can be subject to a magnetic field because

1. It is close to another wire and therefore in the magnetic field of that wire.
2. A magnetic field is applied, in which case \otimes means the field is going into the paper and \odot means the field is coming out of the paper.

A wire or a charge in a magnetic field will experience a magnetic force. This force is perpendicular to both the direction of current and the magnetic field. To find out the direction of the magnetic force for a positive charge or current (for negative charge just invert the direction of the force), use the **right-hand rule**.

- Your thumb indicates the direction of the magnetic force, \vec{F}
- Your index finger points in the direction of the current, \vec{I}
- Your middle finger points in the direction of the magnetic field, \vec{B}

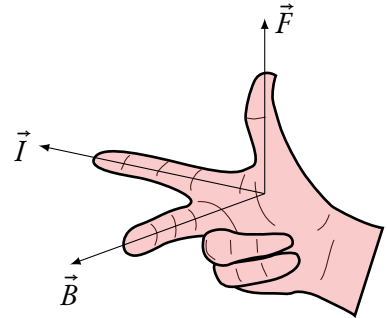

To find the magnitude of the magnetic force, use

$$\text{For a wire: } F = BIL \sin \vartheta$$

$$\text{For a charge: } F = qvB \sin \vartheta$$

B = magnetic field

L = length of wire

v = velocity of charge

ϑ = angle between magnetic field and current

[T]

[m]

[m/s]

When a charge moves parallel to a magnetic field, the angle ϑ is zero and therefore the magnetic force is zero. The force is thus at its maximum when the wire or charge is perpendicular to the magnetic field.

5.5 Movement of a charged particle in a magnetic field

Using right hand rule, it is possible to see that force acting on a moving charged particle is always perpendicular to its velocity. In other words, the speed of the particle does not change, while direction of its movement does. Because of that we get a circular motion (or at least partly circular motion), when inside the magnetic field, shown like in the picture below.

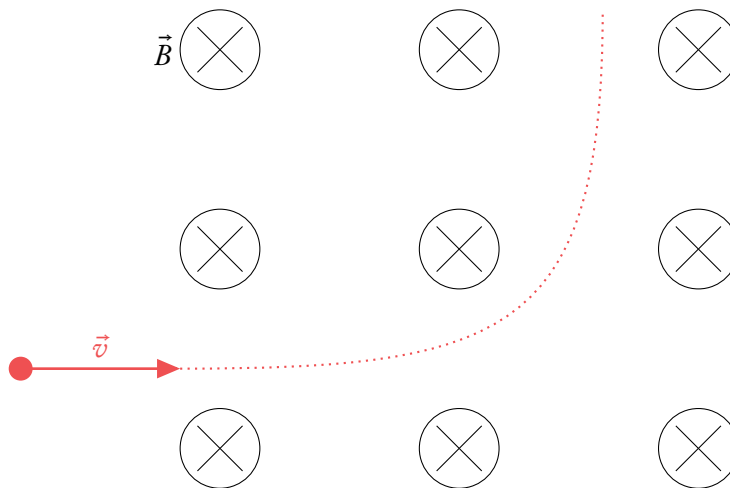

As it can be seen in the picture, the charged positive particle enters the field, and has a force acting on it perpendicular to its velocity. For that reason, the particle does a partly circular motion in the field. Using circular motion equations, it is possible to figure out such things as radius of the circular motion or mass of the particle.

CIRCULAR MOTION AND GRAVITATION

■	6.1. Circular motion	68
■	6.2. Gravitation	70

6.1 Circular motion

So far, we have dealt with motion in a straight line, but circular motion is also very common in everyday life. To accurately describe such type of motion, we'll need to redefine velocity and acceleration, as well as study the force that makes objects move this way.



DB 6.1

Angular velocity tells how fast an object has covered a part of a circle and is given by

$$\omega = \frac{v}{r}$$

$$\begin{aligned} \omega &= \text{angular velocity} \quad [\text{rad/s}] \\ v &= \text{linear velocity} \quad [\text{m/s}] \\ r &= \text{radius} \quad [\text{m}] \end{aligned}$$

Difference between angular velocity and linear velocity

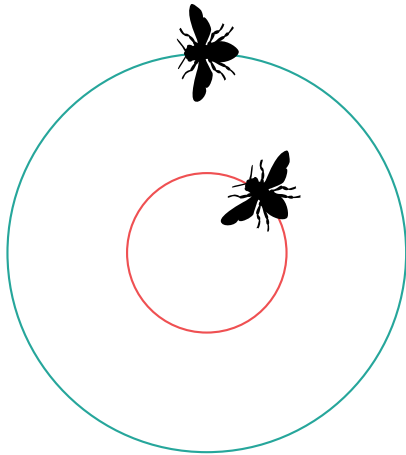

Consider two flies flying a circle, one bigger than the other.

They have the same angular velocity ω when they complete their circle in the same amount of time. But the outer fly would need a higher linear velocity v , because it needs to cover a larger distance.



DB 6.1

Centripetal acceleration is the acceleration a body experiences when moving along a circle.

It is directed towards the centre and causes the body to constantly change direction:

$$a = \frac{v^2}{r} = \frac{4\pi^2 r}{T^2}$$

where T is the period, the time needed for one circulation.

Example.

A skateboarder skates up a hill of 6 m radius. At the top of the hill, he has a speed of 5.2 m/s. Will he lose contact with the ground? For this to happen, the centripetal acceleration should be larger than g , 9.81 m/s^2 .

$$a = \frac{v^2}{r} = \frac{5.2^2}{6} \approx 4.5 \text{ m/s}^2$$

so the skater will stay on the ground.

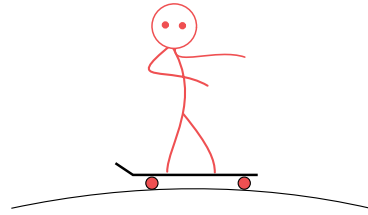

Centripetal force is also directed towards the centre and keeps a body in orbit:

$$F = \frac{mv^2}{r} = m\omega^2 r$$

DB 6.1

It is important to remember that a centripetal force consists of another force: this can be tension, friction, an electric or magnetic force (which will be covered in the electricity and magnetism chapter), or a gravitational force (which will be covered in the next section).

Example.

An 800 kg car takes a circular turn with a diameter of 100 m with a constant speed of 15 m/s. How large is the frictional force on the wheels to make this possible?

As shown in the drawing, friction points to the centre of the circle, making it possible for the car to turn (if you find this hard to understand, think about a car trying to make a turn on ice). So it is friction that provides the centripetal force:

$$F_f = F_c = \frac{mv^2}{r}$$

$$F_f = \frac{800 \cdot 15^2}{50} = 3.6 \text{ kN}$$

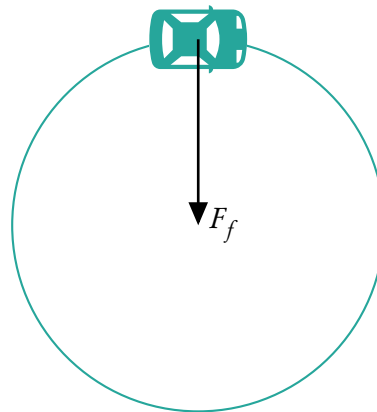

For the exam, you should be aware of the difference between *horizontal rotation* and *vertical rotation*. The latter is a bit trickier because gravitation comes into play.

Think about a pendulum rotating vertically: in this case, the tension in the rope provides the centripetal force.

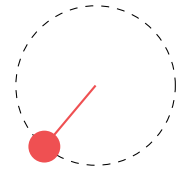

1. Gravity will give an extra pull resulting in more tension. This is where the centripetal force is at its strongest.

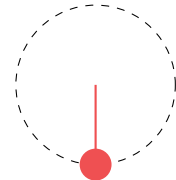

2. Here, gravity works against the tension, resulting in a weaker centripetal force.

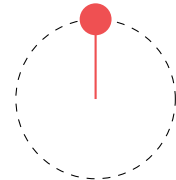

6.2 Gravitation

With Newton's laws we were able to calculate many things — on Earth. But when we put the pendulum described above on the moon, things would look very different.

DB 6.2

Newton realized this and developed a law that can be applied anywhere in the universe, and is therefore rightly called the **universal law of gravitation**.

$$F_G = G \frac{Mm}{r^2}$$

F_G = gravitational force
 G = gravitational constant $6.67 \times 10^{-11} \text{ N m}^2 \text{ kg}^{-2}$
 M = mass of celestial body
 m = mass of object
 r = radius from one centre of mass to the other

If you were to fill in the mass of the Earth as M , your own mass as m , and for r the radius of the Earth, you'd get the amount of gravity acting on you, which is equal to mg . But with this law, you can calculate the *gravitational field strength*, g , for any celestial body. The gravitational field is defined as the force due to gravity per unit mass:

DB 6.2

$$g = \frac{F_G}{m} = G \frac{M}{r^2}$$

For the Earth this is 9.81 m/s^2 , but for the moon or other planets it is something different, and this formula allows you to calculate it.

Example.

On Mars (M), the gravitational field strength is approximately $\frac{1}{4}$ that of Earth (E). The mass of the Earth is approximately ten times that of Mars. What is $\frac{r_E}{r_M}$?

We know $\frac{1}{4}g_E = g_M$ and $m_E = 10m_M$. Using the formula for the gravitational field strength we get

$$\frac{1}{4}G\frac{m_E}{r_E^2} = G\frac{m_M}{r_M^2} \qquad \frac{1}{4}G\frac{10m_M}{r_E^2} = G\frac{m_M}{r_M^2}$$

We can cancel G and m_M since they appear on both sides:

$$\frac{1}{4} \cdot \frac{10}{r_E^2} = \frac{1}{r_M^2}$$

$$\frac{2.5}{r_E^2} = \frac{1}{r_M^2}$$

Multiply both sides by r_E^2 :

$$2.5 = \frac{r_E^2}{r_M^2}$$

$$\frac{r_E}{r_M} = \sqrt{2.5} \approx 1.6$$

It might have crossed your mind during the previous section that circular motion also appears in the solar system: the moon orbiting the Earth, the Earth orbiting the sun, and so on. As has been mentioned in the previous section, it is the gravitational force that provides the centripetal force for these orbits. Let's look at how this works in the next example.

Example.

If we want the orbit of a satellite to be no higher than 5000 km above Earth, what is the maximum velocity it should have?

The following data are available:

- Mass of Earth m_E : 6.0×10^{24} kg
- Radius of Earth r_E : 6.4×10^6 m

Since the gravitational force is equal to the centripetal force:

$$F_G = F_c$$

$$G\frac{m_E m}{r^2} = \frac{mv^2}{r}$$

$$G\frac{m_E}{r} = v^2$$

And the radius r is equal to the radius of the Earth r_E plus the height of the satellite h

$$v = \sqrt{G\frac{m_E}{r_E + h}} = \sqrt{6.67 \times 10^{-11} \cdot \frac{6.0 \times 10^{24}}{6.4 \times 10^6 + 5 \times 10^6}} \approx 5.9 \times 10^3 \text{ m/s}$$

which is approximately 21 000 km/h. Quite fast!

ATOMIC AND NUCLEAR PHYSICS

■	7.1. Atomic structure	74
■	7.2. Nuclear structure	76
■	7.3. Radioactivity	77
■	7.4. Nuclear reactions	79
■	7.5. Fission and fusion	80
■	7.6. Elementary particles	83

7.1 Atomic structure

An atom consists of **subatomic particles**: *protons*, *neutrons* and *electrons*. Its nucleus consists of protons and neutrons. Around the nucleus are atomic orbitals where electrons can reside. Each orbital corresponds with a specific amount of energy an electron needs to have to be able to reside in that orbital. An electron can gain or lose energy by absorbing or emitting a photon.

Electron in ground state absorbs a photon

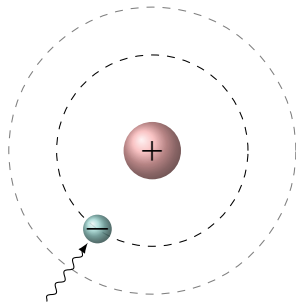

Energized electron jumps to a wider orbit

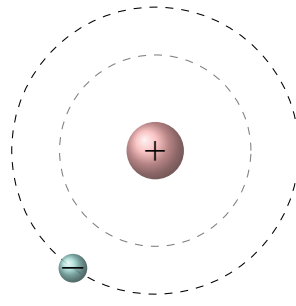

Electron returns to its ground state, emitting a photon

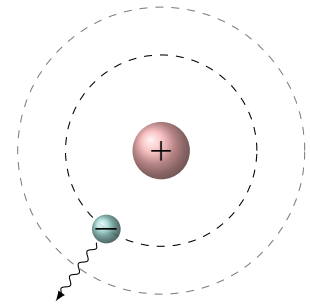

The amount of photon energy absorbed/emitted is thus equal to the energy difference of two electron energy levels:

$$E = hf = \frac{hc}{\lambda}$$

E = emitted/absorbed energy [J]	
h = Planck's constant	$6.626 \times 10^{-34} \text{ J s}$
f = frequency	[Hz]
c = speed of light	[m/s]
λ = wavelength	[m]

Continuous spectrum

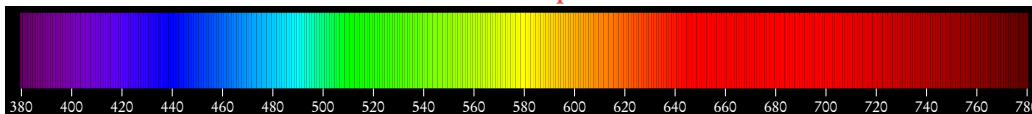

Emission When an electron emits a photon with the right amount of energy, the electron will go to a lower energy state. The lowest state is called ‘ground state’, all the states above are ‘excited states’.

The energy of the emitted photon corresponds to a place on the (visible) spectrum. When emitted photons are passed through a prism emission lines are observed, each line corresponding to the energy difference between two energy levels. This is called an emission spectrum.

Emission spectrum

Hydrogen

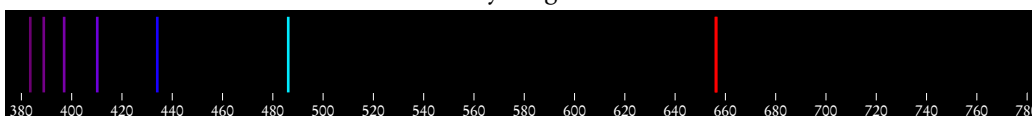

Helium

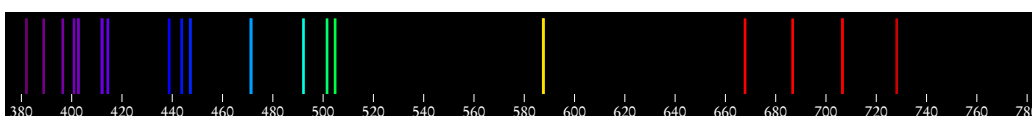

Absorption When an electron absorbs a photon with the right amount of energy, the electron can go to a higher ‘excited state’.

When shining white light (containing photons with all energy levels) on atoms, the photons with the right amount of energy will be absorbed. When passing the remaining light through a prism, the result is a spectrum with dark lines, corresponding to the missing photons. This is called the absorption spectrum.

Absorption spectrum

Hydrogen

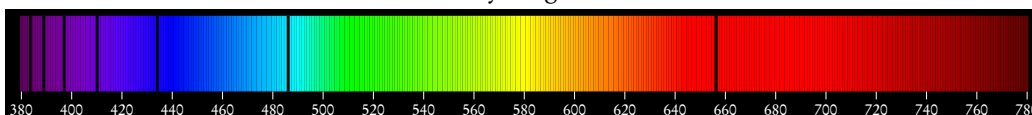

Helium

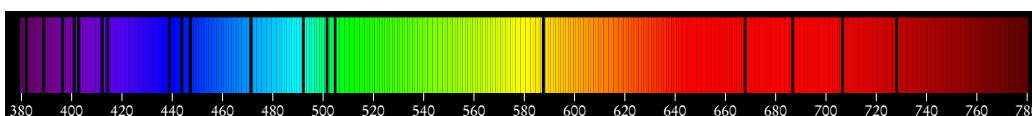

7.2 Nuclear structure



Nucleon is either a neutron or a proton.

Nuclide is a nucleus that contains a specified number of protons and a specified number of neutrons.

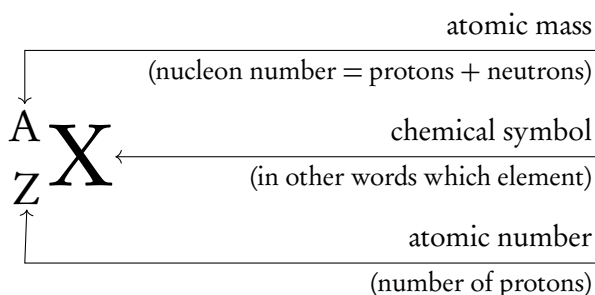

Isotopes Isotopes are variants of the same chemical element with a different amount of neutrons.

For example, ${}^4_2\text{He}$ and ${}^5_2\text{He}$ are isotopes: they are both helium, but one has two neutrons and the other three.

Since all protons are in the nucleus, and like charges repel, there must be a force that holds the protons together and prevents them from falling apart. This force is called the strong nuclear force, and there are a few phenomena that we know this must adhere to:

- It must be strong, as the gravitational attraction is not nearly enough to overcome the electrostatic force that is repelling the protons from each other.
- As the force cannot be observed anywhere other than within the nucleus, it must act on a very short range
- It is likely to involve neutrons as well. Small nuclei tend to have equal number of protons and neutrons. Large nuclei need proportionally more neutrons in order to remain stable.

7.3 Radioactivity



Radioactive decay when an unstable nucleus emits a particle (alpha α , beta β , gamma γ).

- Note that radioactive decay is both a random and spontaneous process.
- Note that the rate of radioactive decay decreases exponentially with time.
- Note that radiation that originates from the atom is often the result of electron transitions. These do not fall under the definition of radioactivity.

Alpha decay when a chunk of the nucleus of an unstable atom is emitted in the form of a helium nucleus ${}^4_2\text{He}^{2+}$. What is left of the atom will have to be such that the protons and neutrons balance on each side of the equation.

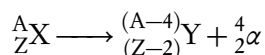

Beta decay, ${}^0_{-1}\beta$ or ${}^0_{-1}e^-$ occurs when a neutron in an unstable atom breaks up into a proton and an electron, of which the electron is then emitted along with an antineutrino. When a positron is emitted, it comes with a neutrino.

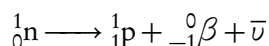

such that

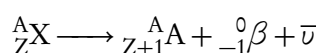

Gamma decay ${}^0_0\gamma$ is somewhat different from the other types of radiation in that they are part of the electromagnetic spectrum. After their emission, the nucleus has less energy but its mass number and its atomic number have not changed. It is said to have changed from an excited state to a lower energy state.

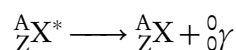

Effects of radiation

All three types of radiation are ionizing. This means that as they go through a substance, collisions occur which causes electrons to be removed from atoms, forming ions. This can be harmful, as it can cause cells to stop working or even become malignant, which can develop as cancer.

	Ionization	Path length through material
Alpha	High	Short
Beta	Average	Average
Gamma	Low	Long

The Rutherford-Geiger-Marsden experiment

Alpha particles were also used in the famous Rutherford-Geiger-Marsden experiment that led to the discovery of the nucleus.

Alpha particles were directed at a thin, metal foil.

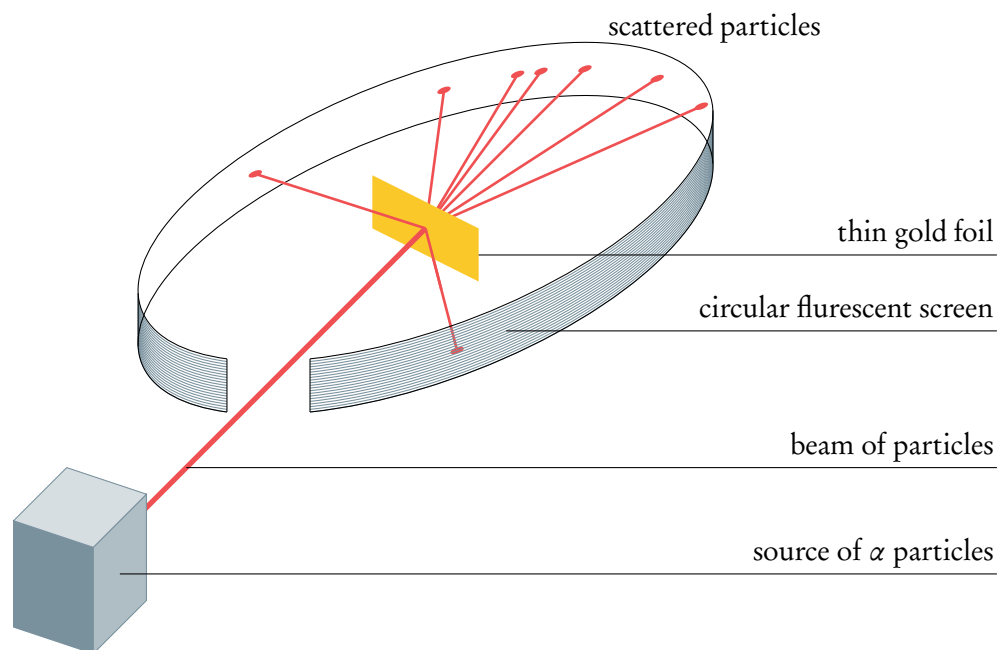

Instead of going straight through the foil as expected, some particles scattered because of:

- Electrostatic repelling force between the positive alpha particle and the positive metal nuclei, proving that the positive charge was concentrated
- Collisions with metal nuclei, causing a deflection of the alpha particles of over 90°. This proves that the metal nuclei were dense and confined to a small region.

Calculating radioactivity with integer half-lives

As it has been already discussed, the radioactive decay decreases exponentially with time. However, it is possible to calculate the amount of radioactive particles left, based on the time passed. One way to do it is to use half-lives.



Half-life Time taken for half of radioactive particles to decay.

In other words, after each half-life we have approximately half of initial amount of radioactive particles left. The rest will decay into something else (possibly also radioactive but we do not consider that part). Since the half-life is usually known, it is possible to find the amount of substance left after an integer amount of half-lives.

Example.

Particle X has half-life of 3 years. What percentage of initial amount of particles X will be left after 12 years?

Since half of particles X decay every 3 years, our half-life will happen $\frac{12}{3} = 4$ times.

Thus the initial amount of particles X will be halved 4 times: $\left(\frac{1}{2}\right)^4 \cdot 100\% = 6.25\%$.

This means that we have 6.25% of initial amount of particles X left after 12 years.

7.4 Nuclear reactions

The individual masses involved in nuclear reactions are tiny ($\sim 10^{-27}$ kg), so in order to compare atomic masses, physicists often use unified mass units, u.



Unified Atomic Mass Unit $\frac{1}{12}$ the mass of Carbon-12, approximately equal to the mass of 1 proton / 1 neutron

7.5 Fission and fusion

7.5.1 Fission



Fission the nuclear reaction whereby a heavy nucleus splits into two smaller nuclei of roughly equal mass, elements heavier than iron release of energy

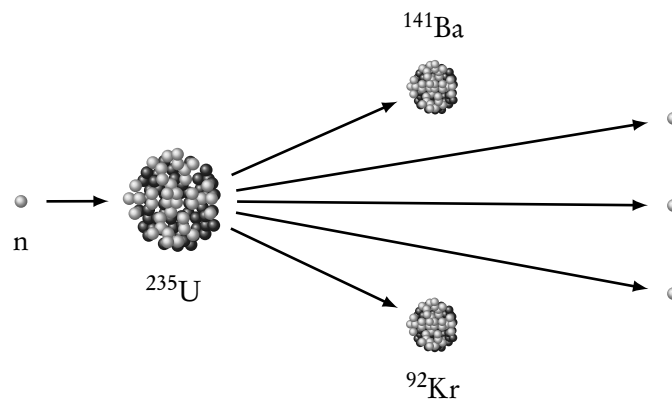

It is the reaction that is used in nuclear reactors and atomic bombs. A typical single reaction might involve bombarding a uranium nucleus with a neutron. This can cause the uranium nucleus to break up into two smaller nuclei.

Only one neutron is needed to initiate the reaction while three are released. Each neutron can continue causing another reaction; this is called a chain reaction.

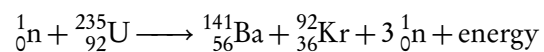

7.5.2 Fusion



Fusion two nuclei 'fuse' to form one larger nuclei, when elements up to iron are formed energy is released in the process. This is the process that fuels stars.

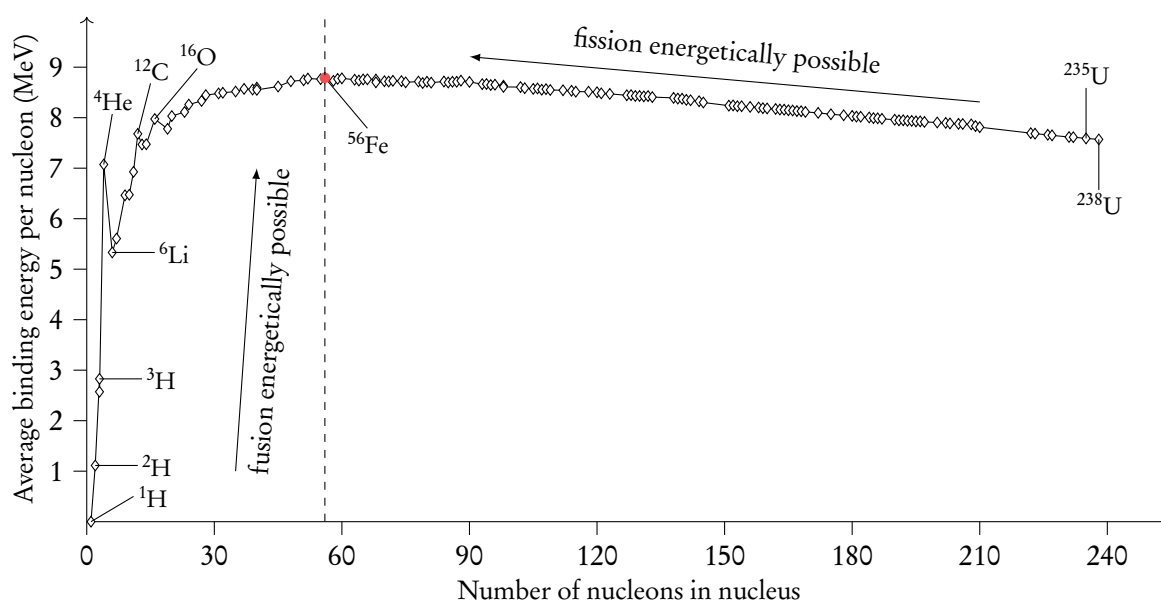
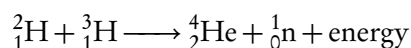

Whenever a nuclear reaction (fission or fusion) releases energy, the products of the reaction are in a lower energy state than the reactants. Loss of mass must be the source of this energy.

In order to compare the energy states of different nuclei, physicists calculate the binding energy per nucleon.

- Binding Energy: energy released when a nuclide is assembled from its individual components. Or, the energy required when the nucleus is separated into its individual components.
- Binding Energy per Nucleon: energy released per nucleon when a nuclide is assembled from its individual components. Or, the energy required per nucleon when the nucleus is separated into its individual components.
- The nucleus with the largest binding energy per nucleon is Iron-56 (shown in the graph above on the highest point). A reaction is energetically feasible if the products of the reaction have a greater binding energy per nucleon than the reactants.

Calculating mass defect

There is energy release during the fission and fusion processes. It is possible to calculate the amount of energy released, using mass defect.



Mass defect is a difference between the mass of the nucleus, and the sum of the masses of the nucleons of which it is composed of.

Example.

Find energy released in the following process:

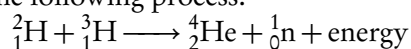

The following information is given:

- ${}^2_1\text{H}$ 2.014 102 u
- ${}^3_1\text{H}$ 3.016 050 u
- ${}^4_2\text{He}$ 4.002 603 u

Where u is defined as unified atomic mass unit, $u = 1.661 \times 10^{-27}$ kg.

First it is required to calculate the mass of both left and right hand sides. It is very important to keep all significant figures at this stage.

Left hand side: $2.014\ 102 + 3.016\ 050 = 5.030\ 152$ u.

Right hand side: $4.002\ 603 + 1.008\ 665 = 5.011\ 268$ u, where 1.008 665 u is mass of neutron, taken from data booklet.

Mass difference $\Delta m = 5.030\ 152 - 5.011\ 268 = 0.018\ 884$ u.

Since we know how to convert from unified mass to kilograms, we can do that at this stage: $0.018\ 884 \cdot 1.661 \times 10^{-27} = 3.136\ 632 \times 10^{-29}$ kg.

Now using $\Delta E = \Delta mc^2$, we get that $\Delta E = 3.136\ 632 \times 10^{-29} \cdot (3 \times 10^8)^2 = 2.82 \times 10^{-12}$ J, which is our answer.

7.6 Elementary particles

7.6.1 Quarks, leptons and exchange particles



Elementary particle is a particle that is not made out of any smaller component particles

Note that protons and neutrons are subatomic, not elementary particles

These are the three classes of elementary particles: quarks, leptons and exchange particles (bosons).

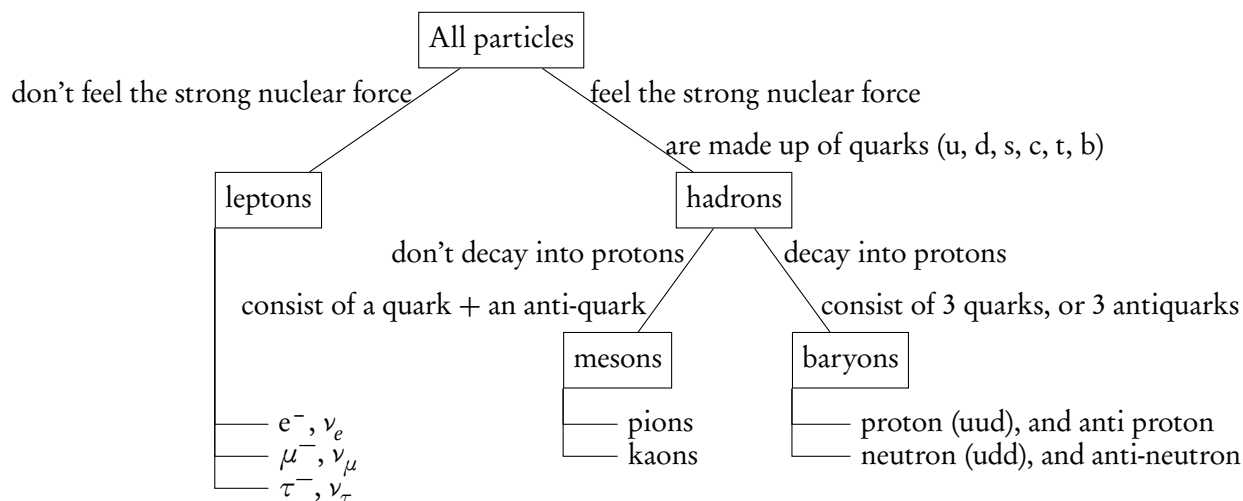

7.6.2 Quarks – strong nuclear forces

Quark flavour	Charge Q	Baryon number B	Strangeness S
Up u	$+2/3e$	$+1/3$	0
Down d	$-1/3e$	$+1/3$	0
Charm c	$+2/3e$	$+1/3$	0
Strange s	$-1/3e$	$+1/3$	-1
Top t	$+2/3e$	$+1/3$	0
Bottom b	$-1/3e$	$+1/3$	0

Each quark has an associated anti-quark which has the same mass, but opposite electric charge and baryon number. So while each quark has baryon number of $+1/3$, and each

anti-quark a baryon number of $-\frac{1}{3}$, the baryon number B of the combined particle is the sum of the baryon numbers of the individual quarks.

3 quarks combine to form baryons (B=1)

Proton p⁺: uud - TUO-Door = two up one down

Neutron n⁰: udd - OUT-Door = one up two down

1 quarks and 1 anti-quark form mesons (B=0)

e.g. **Pion π⁺**: u anti-d, π⁰ & π⁻ form from u/anti-u and d/anti-d quarks
Kaons

Isolating a single quark is impossible, it would require infinite energy.

7.6.3 Leptons – weak nuclear forces

Leptons are *not* made of quarks

There are 6 types of leptons: electron and its neutrino, muon and its neutrino, tau and its neutrino. Tau is the heaviest, then muon, the electron is the lightest. Leptons interact with the weak nuclear interactions, and those with electric charge also interact with the electromagnetic interaction.

Leptons are assigned a quantum number called a **family lepton number: L_e, L_μ, L_τ**. The table below shows the various leptons and their properties. Again, take into account that anti leptons have opposite properties except their mass.

Lepton	Charge	L _e	L _μ	L _τ
e ⁻	-1	+1	0	0
ν _e	0	+1	0	0
μ ⁻	-1	0	+1	0
ν _μ	0	0	+1	0
τ ⁻	-1	0	0	+1
ν _τ	0	0	0	+1

7.6.4 Bosons – exchange particles

Summarizing the elementary particles up to now in a table we have 6 quarks, 6 leptons and apparently 4 more exchange particles that represent the interactions or forces between those. For example, electrostatic interactions are mitigated by photons = γ , the strong nuclear force by gluons = g , and the weak nuclear force by $Z^0/W^+/W^-$ exchange particles and the gravitational force by gravitons.

Gravity and the Higgs boson are ignored here

	Exchange particles			Interaction	
Quarks	u	c	t	γ	EM
	d	s	b	g	SN
Leptons	e^-	μ^-	τ^-	Z	WN
	ν_e	ν_μ	ν_τ	W^\pm	WN

It is worth noting that boson Z carries no charge, while bosons W^\pm carry corresponding positive and negative charges.

The mass of the exchange particle and the range of the interaction are inversely proportional, so while a photon has no mass it has infinite range. When two electrons are repelled due to their similar charges a (virtual) photon is responsible to carry this repelling interaction. These interactions can be shown in Feynman diagrams.

7.6.5 Feynman diagrams

Rules for Feynman diagrams:

- y -axis: Originating particles start at the bottom, produced particles point upwards
- x -axis: Exchange particles change the nature or direction of the originating particles (so after meeting the horizontal vertex the outgoing particles have changed from the ingoing particles).

To determine whether the interaction (horizontal) is γ , W^- or W^+ we must consult the laws of conservation of charge, baryon number and lepton number. The arriving particles are drawn from the bottom (before), the exiting particles to the top (after).

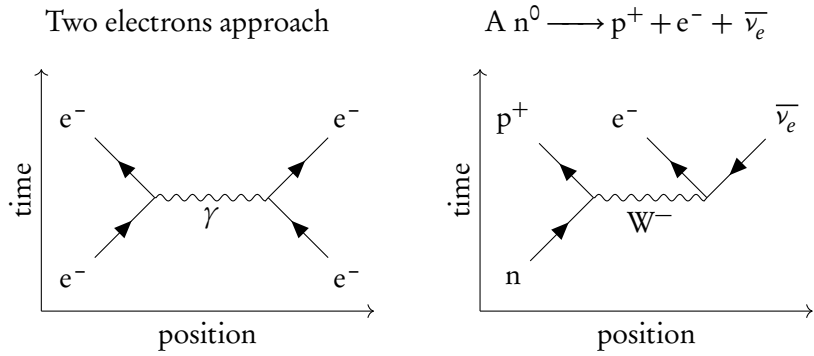

		Left	Right	Change	Left	Right	Change
Q	before	-1	-1	-	0	0	
	after	-1	-1	-	+1	-1	+1 - 1 = 0
B	before	0	0	-	1	0	
	after	0	0	-	1	0	0
L_e	before	+1	+1	-	0	0	
	after	+1	+1	-	+1	-1	+1 - 1 = 0
Exchange particle		γ (no change)			W^- (to balance charge)		

The change in L_μ and L_τ , which are not shown here, should also be 0 (= conservation)

7.6.6 Higgs particle

The theory of quarks, leptons and exchange particles defines the so-called Standard Model of particles and interactions. The centerpiece of this model is the Higgs particle, which is responsible through its interactions for the mass of the particles of the standard model.

ENERGY PRODUCTION



8.1. Energy sources	88
8.2. Thermal energy transfer	93

8.1 Energy sources

We're very dependent on energy, and will probably remain dependent on it in the future. It is therefore important that there are enough energy sources available for future use. How this should be done is a big debate, in which two types of energy are distinguished:



Renewable energy a fuel that is created faster or equally fast as it is consumed.

Non-renewable energy a fuel that is consumed faster than it is created.

In this section, we'll take a look at different types of energy sources, both renewable and non-renewable.



Primary energy all types of unprocessed energy sources (e.g., crude oil)

Secondary energy processed or exploited to mechanical work or electrical forms (e.g., a battery)

To give an indication of how much energy a certain type of fuel can deliver, you can use



Specific energy, E_S is the amount of energy that can be extracted from a unit *mass* of fuel.

Energy density, E_D is the amount of energy that can be extracted from a unit volume of fuel mass.

They are related by $E_D = \frac{\text{mass}}{\text{volume}} E_S$.

Here are examples of the specific energy and energy density of some fuels.

Table 8.1: Specific energy or energy density of fossil fuels

Fuel	Specific Energy $E_s/\text{J kg}^{-1}$	Energy density $E_D/\text{J m}^{-3}$
uranium-235	7.0×10^{13}	1.3×10^{18}
hydrogen	1.4×10^8	1.0×10^7
natural gas	5.4×10^7	3.6×10^7
gasoline	4.6×10^7	3.4×10^{10}
kerosene	4.3×10^7	3.3×10^{10}
diesel	4.6×10^7	3.7×10^{10}
coal	3.2×10^7	7.2×10^{10}

8.1.1 Fossil fuels



Fossil fuels are produced by the decomposition of buried animal and plant material due to pressure and bacteria. Examples of fossil fuels are coal, oil and natural gas.

Fossil fuels make up most of the total energy production. Unfortunately, they emit a lot of carbon dioxide, which causes global warming.

Advantages

- Cheap
- High power output
- Ease of use

Disadvantages

- Non-renewable
- Environmental hazards

To show the efficiency of a power plant, we can use a Sankey diagram:

Sankey diagram

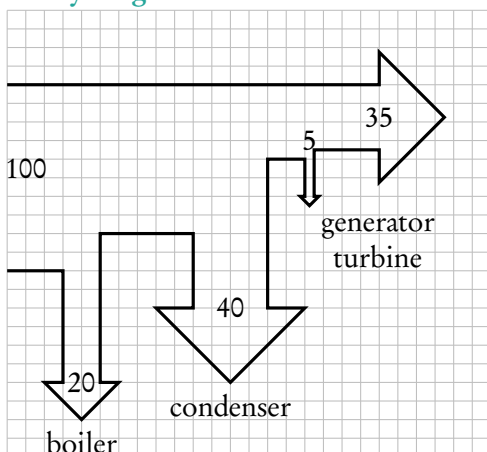

To find the efficiency, check the input power at the left of the Sankey diagram and the useful power at the right of the Sankey diagram. Then use

$$\text{efficiency} = \frac{\text{useful power}}{\text{input power}}$$

In this case,

$$\text{efficiency} = \frac{3.5}{10} = 35\%$$

To calculate the power, use

$$\text{power} = \frac{\text{energy}}{\text{time}}$$

Exercise

8.1.2 Nuclear power



Nuclear power a nuclear reactor is a machine in which nuclear fission reactions take place producing energy.

The fuel used is uranium-235. Can you remember this reaction from the last topic?

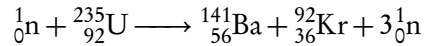

Reaction process

This is a self sustained reaction, because it is a *chain reaction*. For the reaction to get going, we need to have minimum mass called the *critical mass* of uranium. To control the reaction, neutrons are slowed using a *moderator* which is usually a material surrounding the *fuel rods*. The moderator (usually graphite or water) will heat up and this heat may be extracted using a *heat exchanger*. Finally, *control rods* may be introduced to absorb neutrons and thus decrease the rate of reaction.

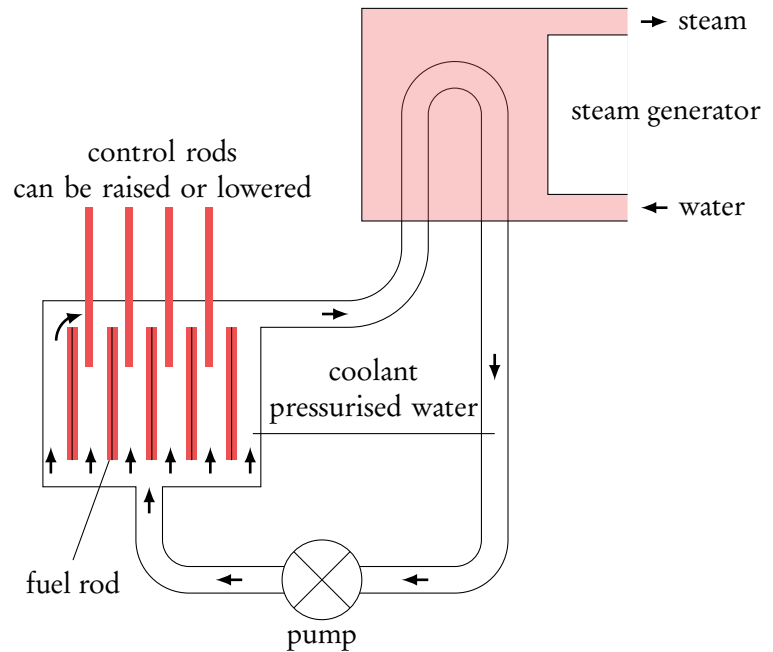

Advantages

- High power output
- Large reserves of nuclear fuels
- No greenhouse gases

Disadvantages

- Disposing of radioactive waste
- Uranium mining
- Risk of nuclear explosion

8.1.3 Solar power



There are two methods to harness the energy from the sun:

Solar panels collect heat, from which water in pipes underneath is heated.

Photovoltaic cells convert light directly into electricity.

8.1.4 Hydroelectric power



Hydroelectric power power derived from moving masses of water.

In a hydroelectric system, water falls from a reservoir down to a power station, so that potential energy is transferred to kinetic energy. The falling water passes through turbines, transferring kinetic energy to electric energy. When energy is not in demand (for example during the night) the water can be pumped back up.

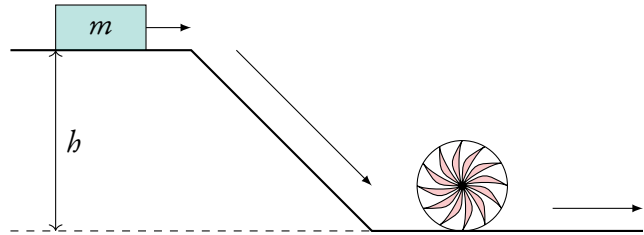

8.1.5 Wind power



Wind power power derived from moving masses of air.

Wind power speaks for itself. Given, we have all seen wind generators at some point. Typically about ~ 30% of the power carried in wind is converted to energy as shown by Sankey diagram on the right.

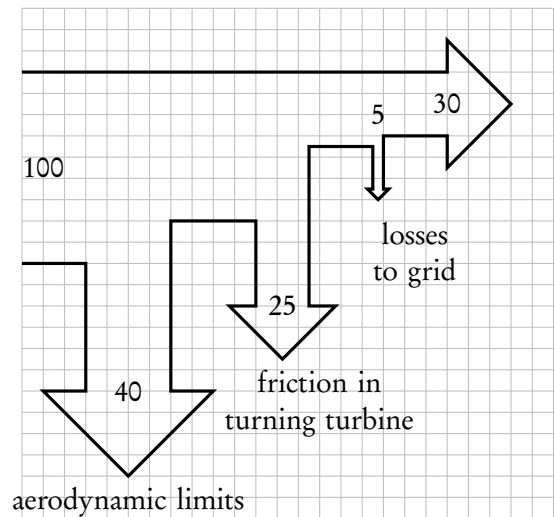

Derivation

Consider the mass of air that can pass through a tube of cross sectional area A with velocity v in time Δt . The air density is ρ .

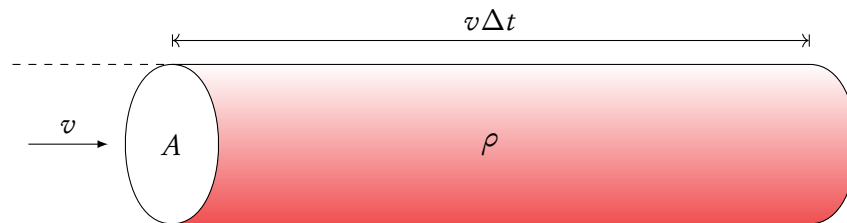

1. $m = \rho Av\Delta t$ (mass of air)
2. Kinetic energy of air is $E = \frac{1}{2}mv^2 = \frac{1}{2}\rho Av\Delta t v^2 = \frac{1}{2}\rho A\Delta t v^3$
3. Power = $\frac{E}{\Delta t} = \frac{1}{2}\rho Av^3$

Energy source	Advantages	Disdvantages
Solar	Cheap Renewable Clean	Low power output Inconsistent
Hydroelectric	Cheap Clean	Water storage Damage to local ecology
Wind	Clean Renewable	Large infrastructure Inconsistent

8.2 Thermal energy transfer

Heat can be transferred by three different methods.



Conduction is the transfer of energy due to high energy electrons colliding with neighbouring molecules.

Convection is best explained by an example.

Air over a hot radiator in a room is heated, expands and rises, transferring warm air to the rest of the room. Cold air takes its place through convection currents and the process repeats.

Radiation is the transfer of energy through electromagnetic radiation.

Black-body radiation The power radiated by a body is governed by Stefan-Boltzman law

$$P = \varepsilon \sigma AT^4$$

P	= power	$[\text{J s}^{-1}]$
ε	= emissivity	
σ	= Stefan-Boltzmann constant	$5.67 \times 10^{-8} \text{ Wm}^{-2}\text{K}^{-4}$
A	= area	$[\text{m}^2]$
T	= thermodynamic temperature	$[\text{K}]$

Emissivity ε measures how effectively a black-body radiates.
 $\varepsilon = 1 \Rightarrow$ black body.

Most energy is radiated at a specific wavelength λ_{max} determined by Wien's displacement law:

$$\lambda_{\text{max}} T = 2.90 \times 10^{-3}$$

λ_{max}	= wavelength for which maximum intensity (so <i>not</i> maximum wavelength)
T	= temperature in kelvin $[\text{K}]$

This is shown for various temperatures in figure 8.1.

Intensity is the power of radiation received per unit area:

$$I = \frac{P}{A} = \frac{P}{4\pi r^2}$$

A	= total surface over which power from radiating body has spread
r	= distance from radiating body to receiving body

Figure 8.1

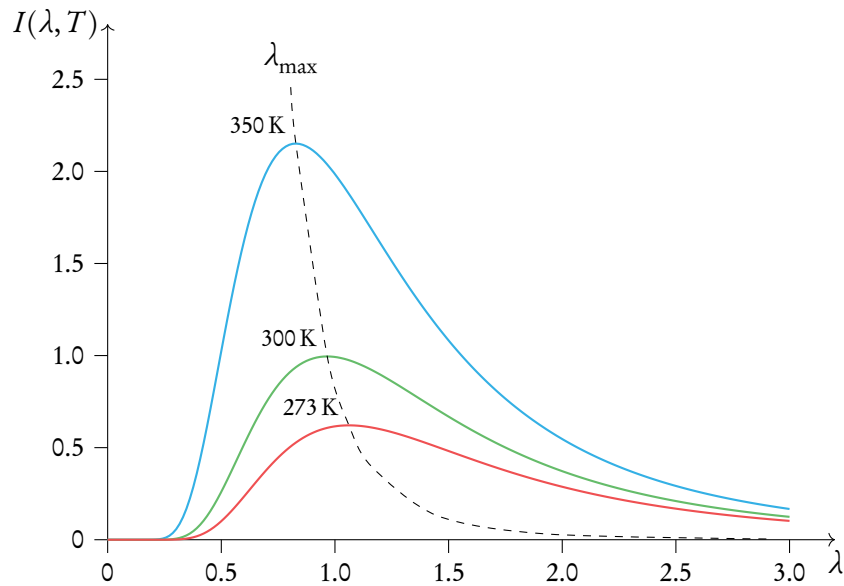

Solar constant S is the amount of solar radiation at the mean distance from the sun to the Earth.

$$S = \frac{P}{4\pi R^2} = 1400 \text{ W/m}^2$$

R = mean distance from sun to Earth's orbit around sun

To indicate how much of the total incident power is scattered, we can use **albedo**:

$$\text{albedo} = \alpha = \frac{\text{total scattered power}}{\text{total incident power}}$$

The fraction of absorbed power is thus $1 - \alpha$.

Using albedo we can find the average intensity incident on Earth:

$$I = \frac{\pi r^2}{4\pi r^2} (1 - \alpha) S$$

r = radius of Earth
 πr^2 = area of Earth facing the sun
 $4\pi r^2$ = total area of Earth

Temperature at Earth's surface

We are interested in average temperature at the Earth's surface. The Earth radiates power from the entire surface area of its spherical shape, so the power radiated is

$$P_{\text{out}} = \sigma AT^4$$

We are assuming Earth to be black body so, $\varepsilon = 1$.

$$I_{\text{out}} = \frac{P_{\text{out}}}{A} = \sigma T^4$$

Equating the incident and outgoing intensities we get

$$\frac{(1-\alpha)S}{4} = \sigma T^4$$

Solving the equation, we get

$$T = \sqrt[4]{\frac{(1-\alpha)S}{4\sigma}}$$

This evaluates to

$$T = \sqrt[4]{\frac{245}{5.67 \times 10^{-8}}} = 256 \text{ K}$$

This temperature is -17°C .

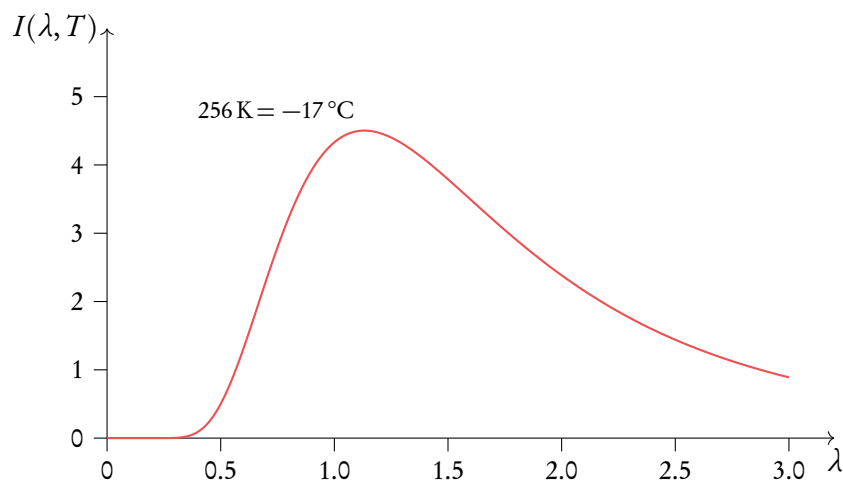



Greenhouse effect Greenhouse gases strongly absorb infrared radiation from the atmosphere, when re-radiated in all directions, these gases account for additional warming. These gases include water vapour, carbon dioxide, methane and nitrous oxide.

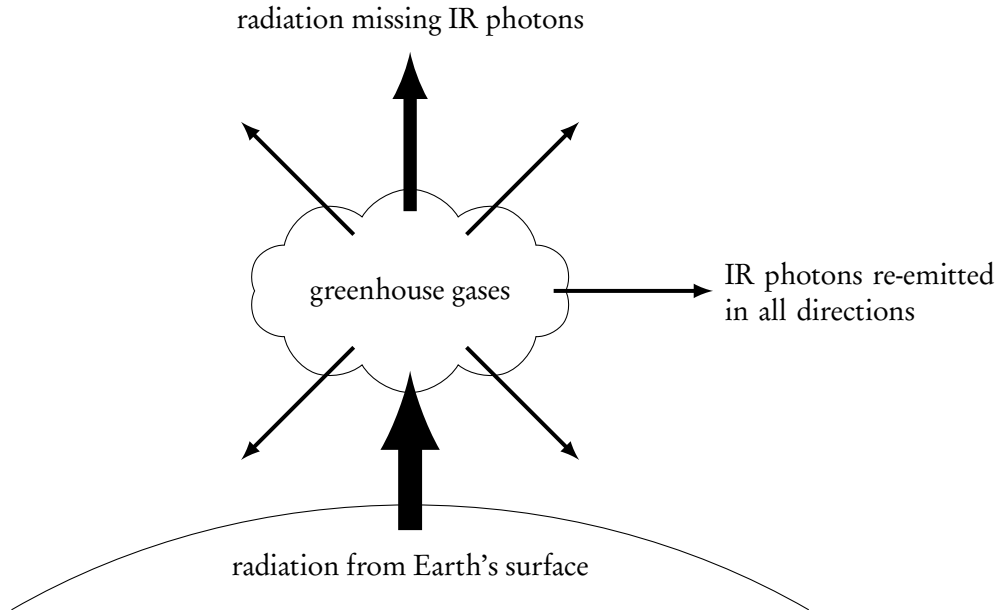

Table 8.2: Sources of greenhouse gases

Greenhouse gas	Natural Sources	Anthropogenic sources
H ₂ O	evaporation of water from oceans, rivers and lakes	irrigation
CO ₂	forest fires, volcanic eruptions, evaporation of water from oceans	burning fossil fuels in power plants and cars, burning forests
CH ₄	wetlands, oceans, lakes and rivers, termites	flooded rice fields, farm animals, procession of coal, natural gas and oil, burning biomass
N ₂ O	forests, oceans, soil and grasslands	burning fossil fuels, manufacture of cement, fertilizers, deforestation (reduction of nitrogen fixation in plants)

EXAM TIPS

Paper 1

- The biggest tip: use logic. A lot of answers can be simplified or simply guessed using logic.
- Since it is possible to guess, always, no matter what, answer all questions. You don't get negative points for guessing wrong.
- Expect all topics, around 2–4 questions per each one.
- Use time wisely. You have around 1.5 min per question, but you also need to fill out the answers sheet. Leave at least 5 minutes at the end of the exam to do that (*very important!*).
- One common question type is where you are given three statements and it is required to choose which of those are correct: if you are able to eliminate one statement, most of the time you should be able to automatically find the right answer.
- Use elimination method: quite often it is possible to eliminate at least 1–2 answers using logic.
- There is no calculator on the Paper. Thus, when it is required to calculate something: approximate all the values. Gravitational constant is about 10, π is about 3 etc.
- When asked to estimate an answer, you can do reasonable assumptions. Example: a mass of a boy can be estimated as around 50 kg. From there you can choose the closest answer (usually answers have significant difference, like magnitude of 10, so it is okay to be a bit off with the estimate).
- Lots of questions have similar patterns or are similar type questions: do a few past papers before the exam.

Paper 2

- You have around 1.4–1.5 minutes per mark. Skip hard questions and come back to them later, otherwise you might not have enough time for easy marks.
- While not all topics might come up on Paper 2, it is hard to predict which ones will: you still have to study for everything.
- If you do not know how to do a question, at least put a formula you think is applicable. Quite often you do get a single mark for stating the formula.
- When drawing graphs, use a pencil and a ruler (if it is a straight line). Only draw a single, clear line, not many lines on top of each other (like if you are sketching something).
- If you are required to draw a free-body diagram and label the forces: be precise with labeling. It is not “gravity”, but “weight”.
- When asked to derive an equation, be sure to include all intermediate steps. Examiners do not care as much about the result (usually it is already given), but they give points for intermediate steps.
- Try to always include units. They are not always required, but better not risk it.
- Be sure to give the answer to the right number of significant figures.
- Lately there have been many more questions about “suggest why”, “explain how”, “outline why”. Try to prepare for them as well.
- Remember to write only within boxes. Everything else will not be checked (so you can draw outside of boxes for yourself, if you want to).

Paper 3

- Most of the Paper 2 tips are applicable to Paper 3, but there are some differences.
- You must answer all questions from Section A and *only one* option from Section B. Section A is about experiments and uncertainties. Section B is options. You are given all options in Section B, so be sure you answer only yours.
- Section A will have a lot of questions about graphing, uncertainties and errors. Be sure to know the difference between absolute, percentage and fractional uncertainties.
- You might be given an experiment you have never performed. Most of the time you are not required to fully understand it, so just try to do exactly what the question is asking.
- When suggesting how to improve the experiment, think from logical stand point, what were the biggest sources of errors and how one could eliminate them.
- Be sure to double check that you have answered only your option.

EXAM TIPS